

**Maytree Infants & Nursery School**

**Water System Drawings**

**31<sup>st</sup> July 2017**



Butler Sink

Hot Flow  
Mains Water

Cleaners Room  
Area 6

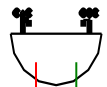

Hot Flow  
Mains Water

Medical Room  
Area 5

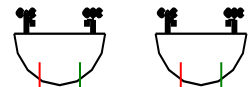

Mains Water

TMV

Hot Flow

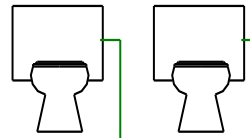

Mains Water

Assumed Mains Water  
Hot Flow  
Staff Toilet  
Area 4

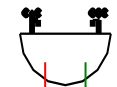

Mains Water

Disabled Toilet  
Area 3

**KEY**

- Ball A Fix Valve
- bf
- Check Valve
- Laboratory Tap
- Blender Valve
- Pump
- Isolating Valve
- Safety Valve
- Drinking Fountain
- Shower
- Mains Water Service
- Cold Water Down Service
- Hot Flow/Return

**Note**

This drawing was prepared for the Legionellosis Risk Assessment Report and not intended as a scaled system drawing. Drawings are based on a visual inspection carried out during the Risk Assessment and information given at the time of the survey. Some areas of pipe work may not have been visible during the survey therefore some assumptions may have been made in order to create this drawing. This drawing is not to scale.

*Freeston Water Treatment  
Unit 1  
Lulworth Business Centre  
Calmore Industrial Estate  
Totton Southampton  
SO40 3WW  
Tel 02380669713*

Site Ref  
Maytree Infants School  
Admin / Reception Area

Date 31st July 2017

Drawing No.2

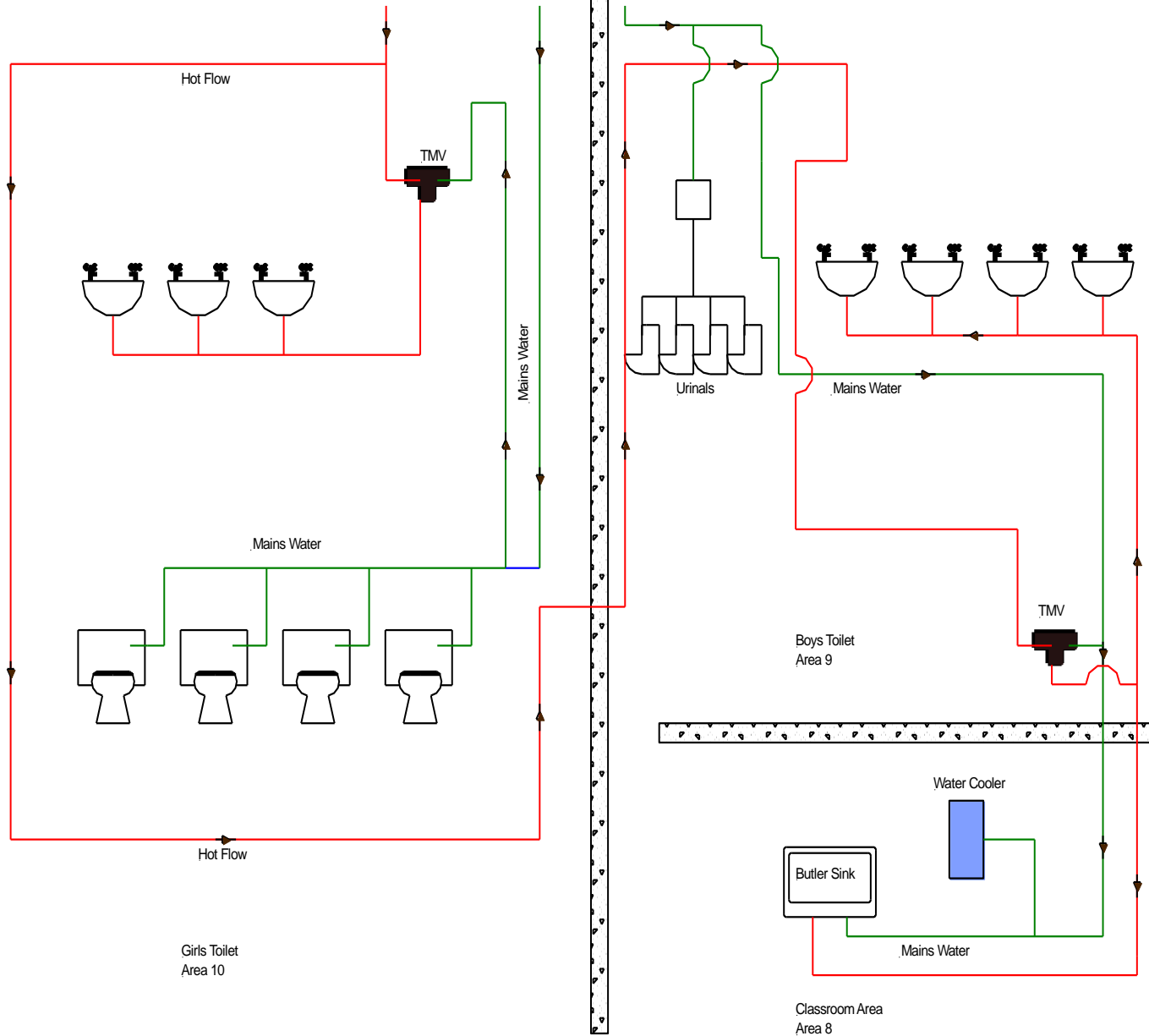

**KEY**

- Ball A Fix Valve
- bf
- Check Valve
- Laboratory Tap
- Blender Valve
- Pump
- Isolating Valve
- Safety Valve
- Drinking Fountain
- Shower
- Mains Water Service
- Cold Water Down Service
- Hot Flow/Return

**Note**  
 This drawing was prepared for the Legionellosis Risk Assessment Report and not intended as a scaled system drawing. Drawings are based on a visual inspection carried out during the Risk Assessment and information given at the time of the survey. Some areas of pipe work may not have been visible during the survey therefore some assumptions may have been made in order to create this drawing. This drawing is not to scale.

*Freeston Water Treatment Unit 1  
 Lulworth Business Centre  
 Calmore Industrial Estate  
 Totton Southampton  
 SO40 3WW  
 Tel 02380669713*

Site Ref  
 Maytree Infants School  
 Year 1  
 Toilets & Classroom Areas

Date 31st July 2017

Drawing No.3

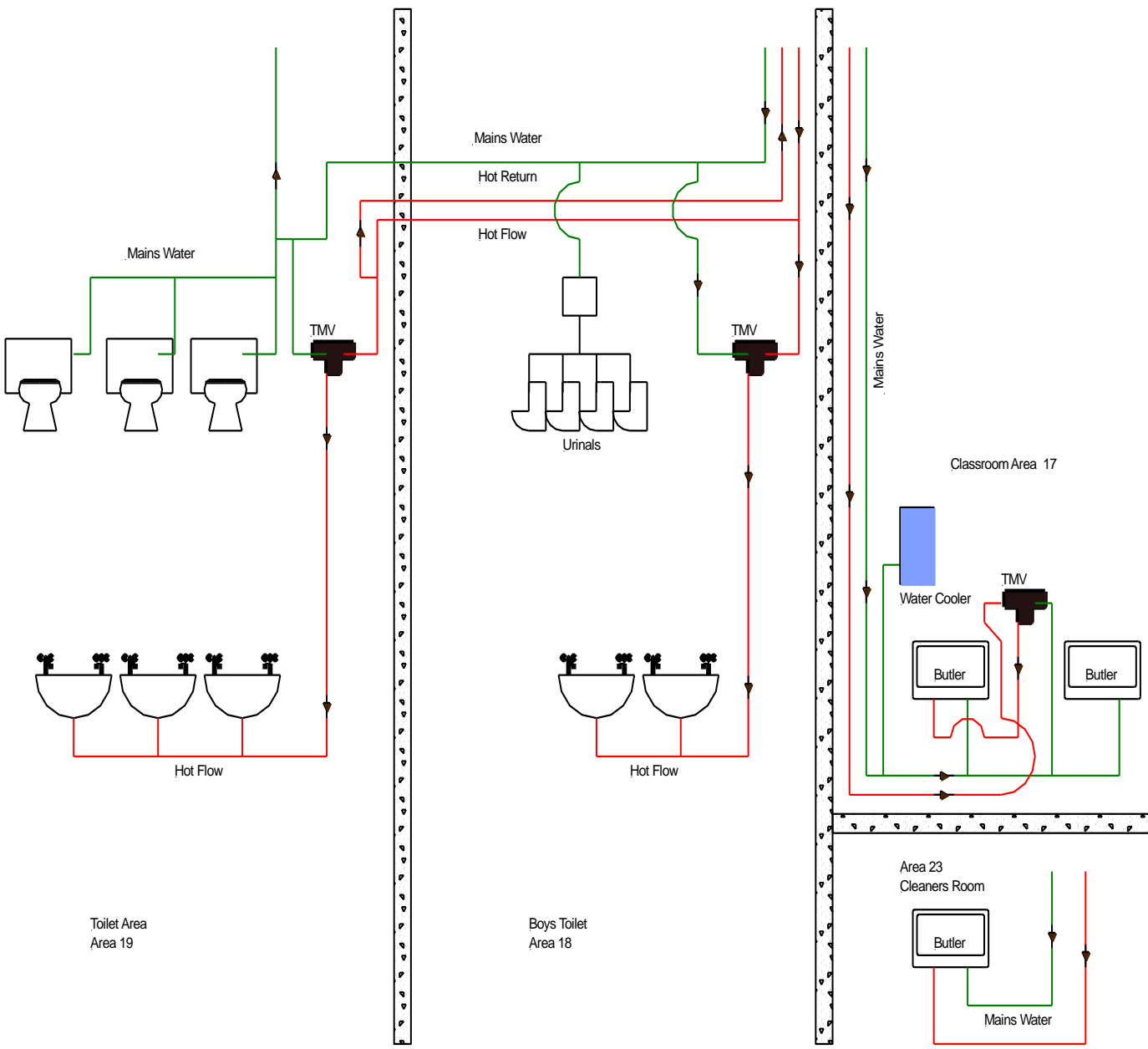

**KEY**

-  Ball A Fix Valve
-  bf
-  Check Valve
-  Laboratory Tap
-  Blender Valve
-  Pump
-  Isolating Valve
-  Safety Valve
-  Drinking Fountain
-  Shower
-  Mains Water Service
-  Cold Water Down Service
-  Hot Flow/Return

**Note**  
 This drawing was prepared for the Legionellosis Risk Assessment Report and not intended as a scaled system drawing. Drawings are based on a visual inspection carried out during the Risk Assessment and information given at the time of the survey. Some areas of pipe work may not have been visible during the survey therefore some assumptions may have been made in order to create this drawing. This drawing is not to scale.

*Freeston Water Treatment  
 Unit 1  
 Lulworth Business Centre  
 Calmore Industrial Estate  
 Totton Southampton  
 SO40 3WW  
 Tel 02380669713*

Site Ref  
 Maytree Infants School  
 Areas 17, 18, 19 & 23  
 Toilet Area & Cleaners Room  
 Date 31st July 2017

Drawing No.4

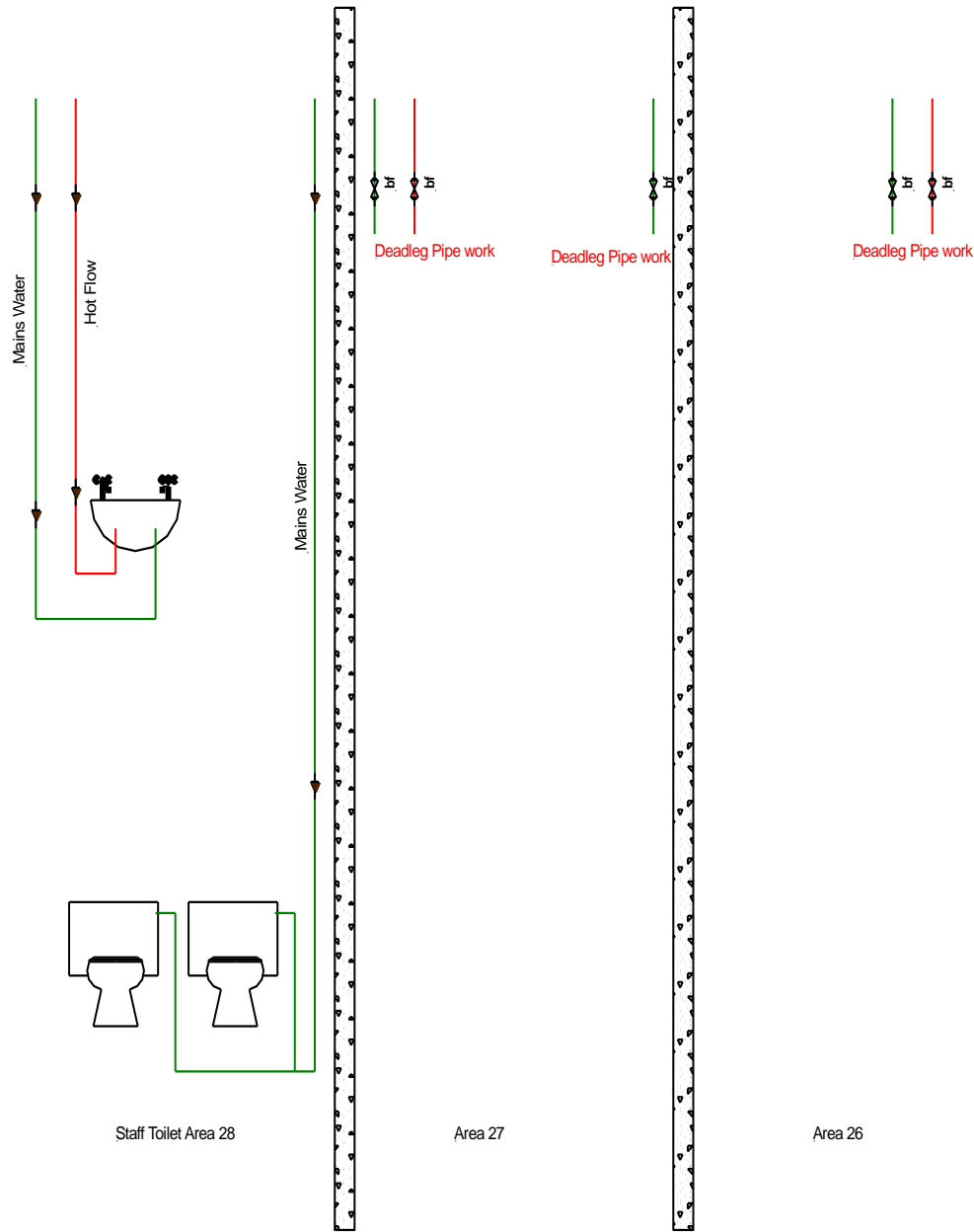

### KEY

- Ball A Fix Valve
- bf
- Check Valve
- Laboratory Tap
- Blender Valve
- Pump
- Isolating Valve
- Safety Valve
- Drinking Fountain
- Shower
- Mains Water Service
- Cold Water Down Service
- Hot Flow/Return

### Note

This drawing was prepared for the Legionellosis Risk Assessment Report and not intended as a scaled system drawing. Drawings are based on a visual inspection carried out during the Risk Assessment and information given at the time of the survey. Some areas of pipe work may not have been visible during the survey therefore some assumptions may have been made in order to create this drawing. This drawing is not to scale.

*Freeston Water Treatment  
Unit 1  
Lulworth Business Centre  
Calmore Industrial Estate  
Totton Southampton  
SO40 3WW  
Tel 02380669713*

Site Ref  
Maytree Infants School  
Seemas Area 26, 27 & 28

Date 31st July 2017

Drawing No.5

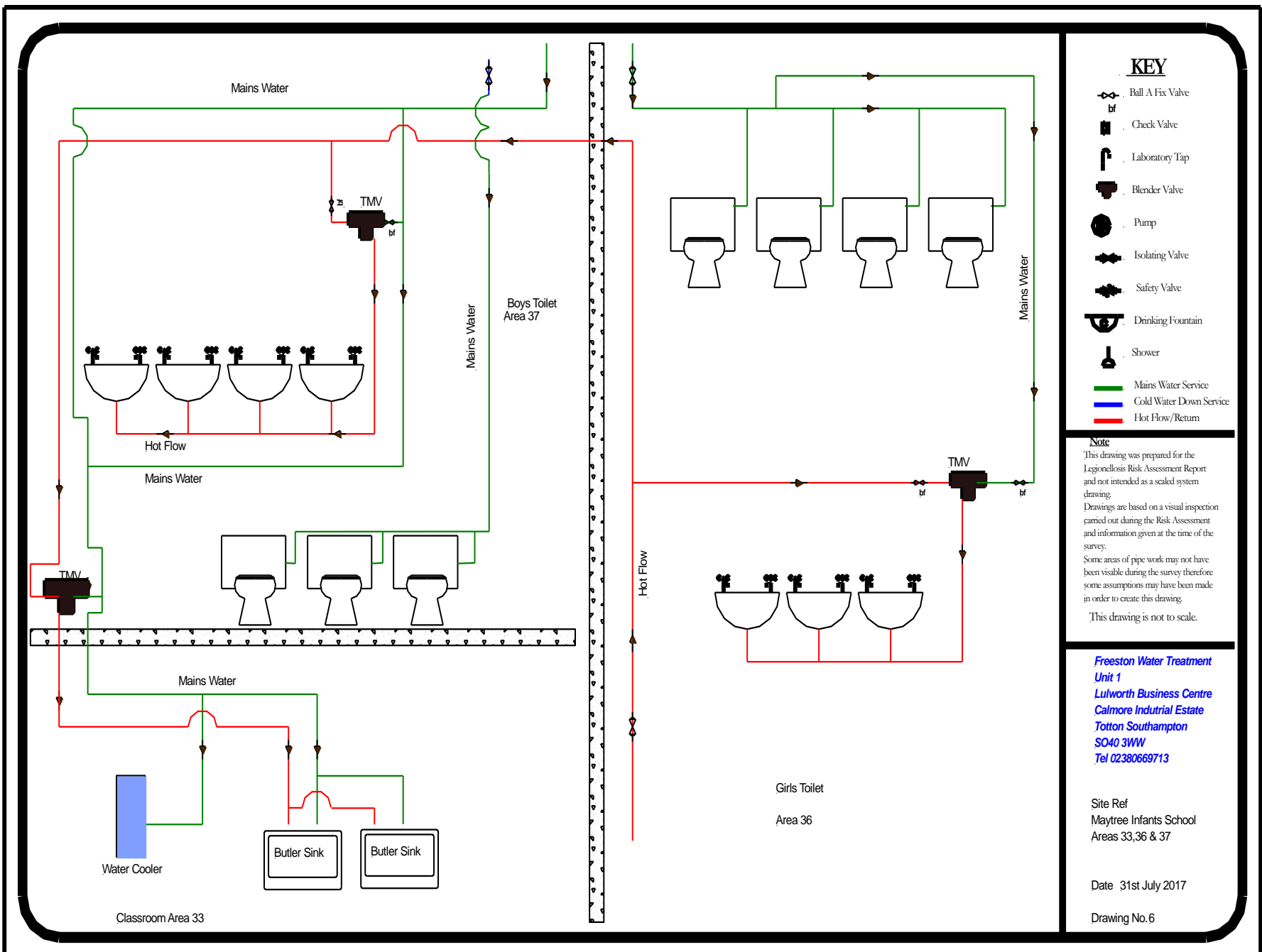

**KEY**

- Ball A Fix Valve
- bf
- Check Valve
- Laboratory Tap
- Blender Valve
- Pump
- Isolating Valve
- Safety Valve
- Drinking Fountain
- Shower
- Mains Water Service
- Cold Water Down Service
- Hot Flow/Return

**Note**  
 This drawing was prepared for the Legionellosis Risk Assessment Report and not intended as a scaled system drawing. Drawings are based on a visual inspection carried out during the Risk Assessment and information given at the time of the survey. Some areas of pipe work may not have been visible during the survey therefore some assumptions may have been made in order to create this drawing. This drawing is not to scale.

*Freeston Water Treatment  
 Unit 1  
 Lulworth Business Centre  
 Calmore Industrial Estate  
 Totton Southampton  
 SO40 3WW  
 Tel 02380669713*

Site Ref  
 Maytree Infants School  
 Areas 33,36 & 37

Date 31st July 2017

Drawing No.6

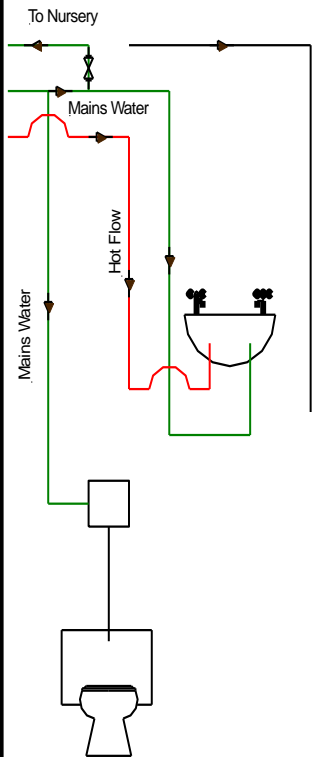

Site Managers Office  
Area 53

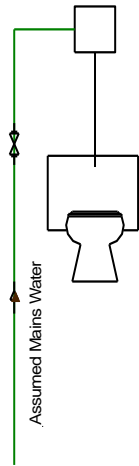

Servery Toilet  
Area 47

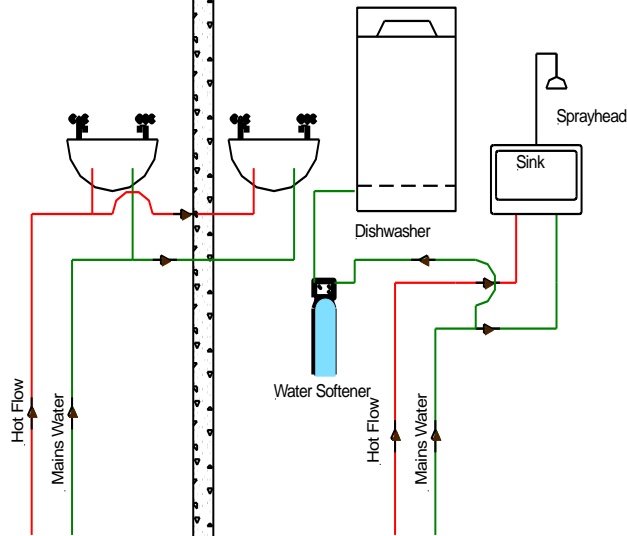

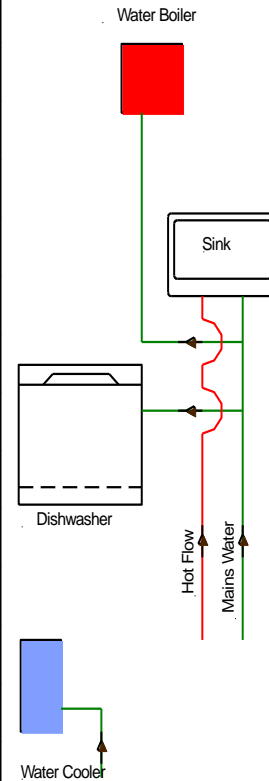

Servery / Kitchen  
Area 44



Staff Room  
Area 41

### KEY

-  Ball A Fix Valve
-  bf
-  Check Valve
-  Laboratory Tap
-  Blender Valve
-  Pump
-  Isolating Valve
-  Safety Valve
-  Drinking Fountain
-  Shower
-  Mains Water Service
-  Cold Water Down Service
-  Hot Flow/Return

### Note

This drawing was prepared for the Legionellosis Risk Assessment Report and not intended as a scaled system drawing. Drawings are based on a visual inspection carried out during the Risk Assessment and information given at the time of the survey. Some areas of pipe work may not have been visible during the survey therefore some assumptions may have been made in order to create this drawing. This drawing is not to scale.

*Freeston Water Treatment  
Unit 1  
Lulworth Business Centre  
Calmore Industrial Estate  
Totton Southampton  
SO40 3WW  
Tel 02380669713*

Site Ref  
Maytree Infants School  
Areas 41, 44, 47 & 53

Date 31st July 2017

Drawing No.7



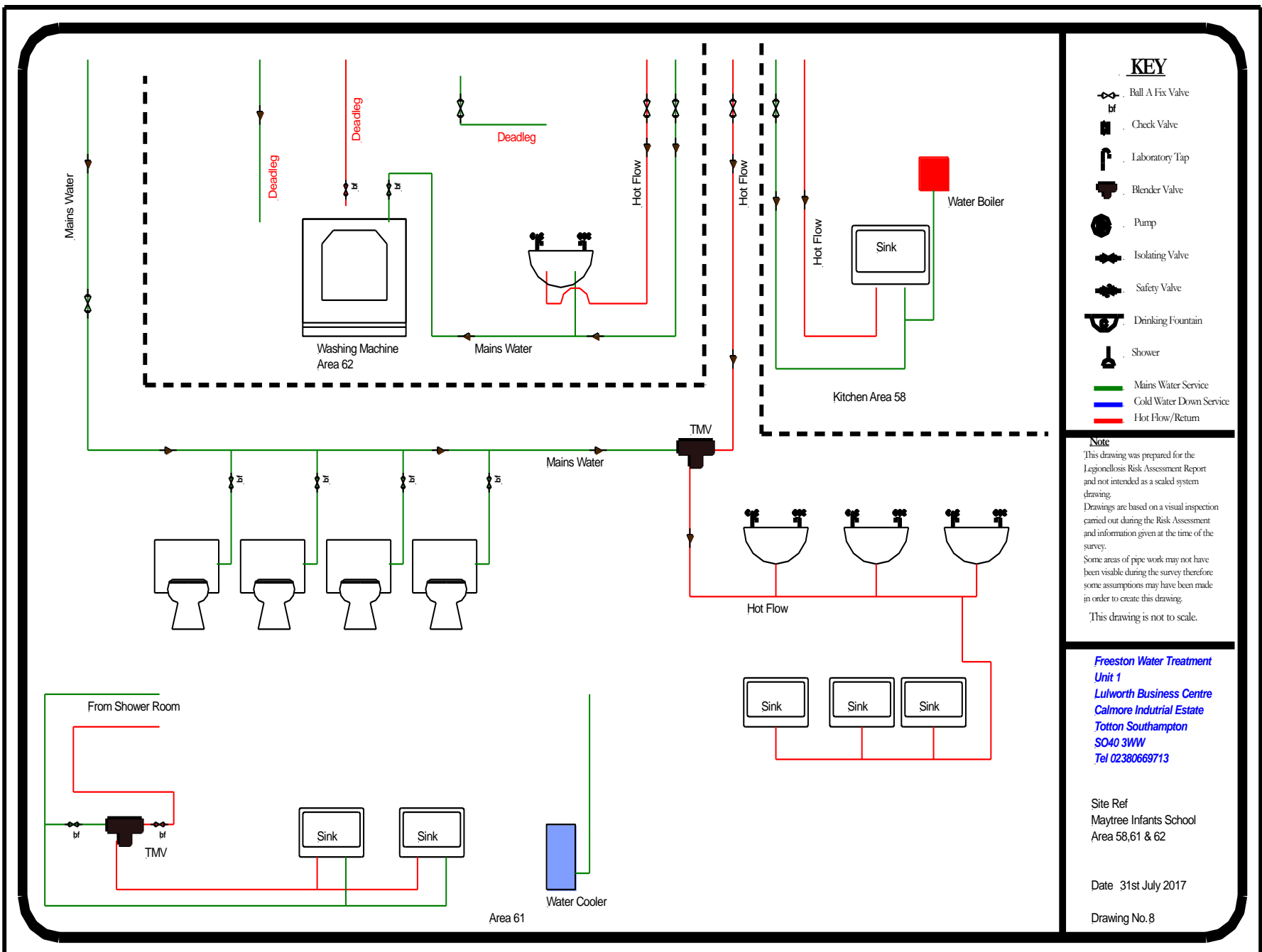

**KEY**

- Ball A Fix Valve
- bf
- Check Valve
- Laboratory Tap
- Blender Valve
- Pump
- Isolating Valve
- Safety Valve
- Drinking Fountain
- Shower
- Mains Water Service
- Cold Water Down Service
- Hot Flow/Return

**Note**  
 This drawing was prepared for the Legionellosis Risk Assessment Report and not intended as a scaled system drawing. Drawings are based on a visual inspection carried out during the Risk Assessment and information given at the time of the survey. Some areas of pipe work may not have been visible during the survey therefore some assumptions may have been made in order to create this drawing. This drawing is not to scale.

*Freeston Water Treatment Unit 1  
 Lulworth Business Centre  
 Calmore Industrial Estate  
 Totton Southampton  
 SO40 3WW  
 Tel 02380669713*

Site Ref  
 Maytree Infants School  
 Area 58,61 & 62

Date 31st July 2017

Drawing No.8

Area 61

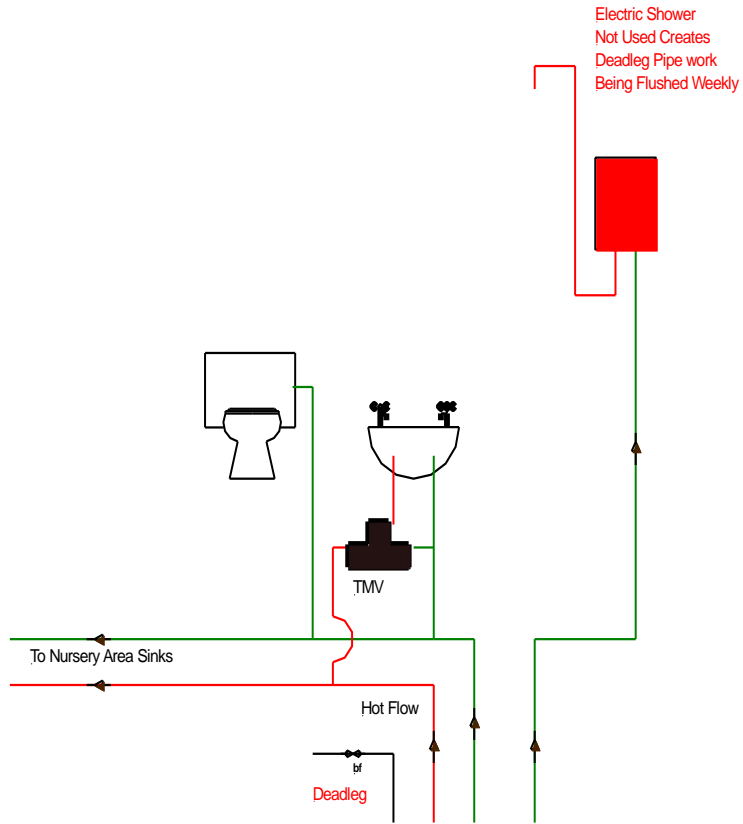

Toilet & Shower Room Area 59

**KEY**

-  Ball A Fix Valve
-  bf
-  Check Valve
-  Laboratory Tap
-  Blender Valve
-  Pump
-  Isolating Valve
-  Safety Valve
-  Drinking Fountain
-  Shower
-  Mains Water Service
-  Cold Water Down Service
-  Hot Flow/Return

**Note**

This drawing was prepared for the Legionellosis Risk Assessment Report and not intended as a scaled system drawing. Drawings are based on a visual inspection carried out during the Risk Assessment and information given at the time of the survey. Some areas of pipe work may not have been visible during the survey therefore some assumptions may have been made in order to create this drawing. This drawing is not to scale.

*Freeston Water Treatment  
Unit 1  
Lulworth Business Centre  
Calmore Industrial Estate  
Totton Southampton  
SO40 3WW  
Tel 02380669713*



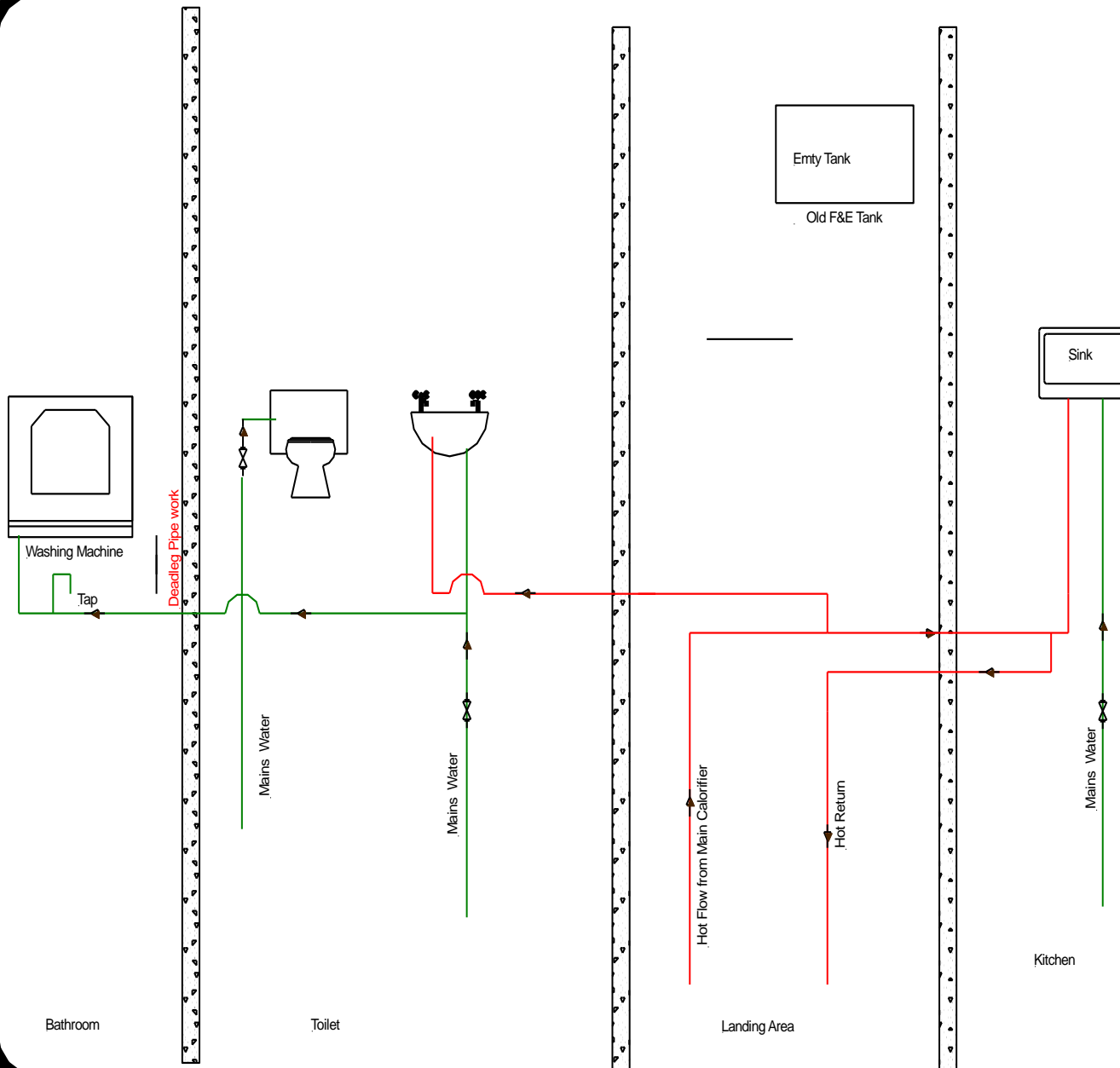

Site Ref  
Maytree Infants School  
Nursery Area 59

Date 31st July 2017

Drawing No.9



### KEY

-  Ball A Fix Valve
-  bf
-  Check Valve
-  Laboratory Tap
-  Blender Valve
-  Pump
-  Isolating Valve
-  Safety Valve
-  Drinking Fountain
-  Shower
-  Mains Water Service
-  Cold Water Down Service
-  Hot Flow/Return

### Note

This drawing was prepared for the Legionellosis Risk Assessment Report and not intended as a scaled system drawing. Drawings are based on a visual inspection carried out during the Risk Assessment and information given at the time of the survey. Some areas of pipe work may not have been visible during the survey therefore some assumptions may have been made in order to create this drawing. This drawing is not to scale.

*Freeston Water Treatment  
Unit 1  
Lulworth Business Centre  
Calmore Industrial Estate  
Totton Southampton  
SO40 3WW  
Tel 02380669713*



Site Ref  
Maytree Infants School  
Flat Area

Date 31st July 2017

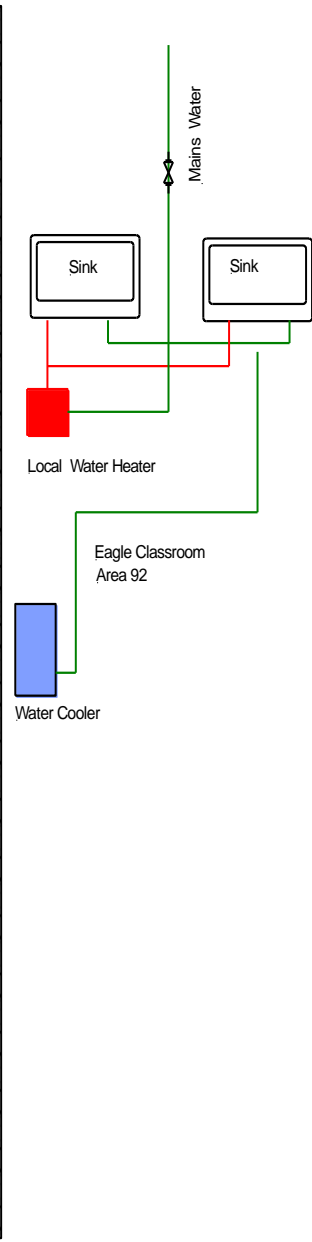
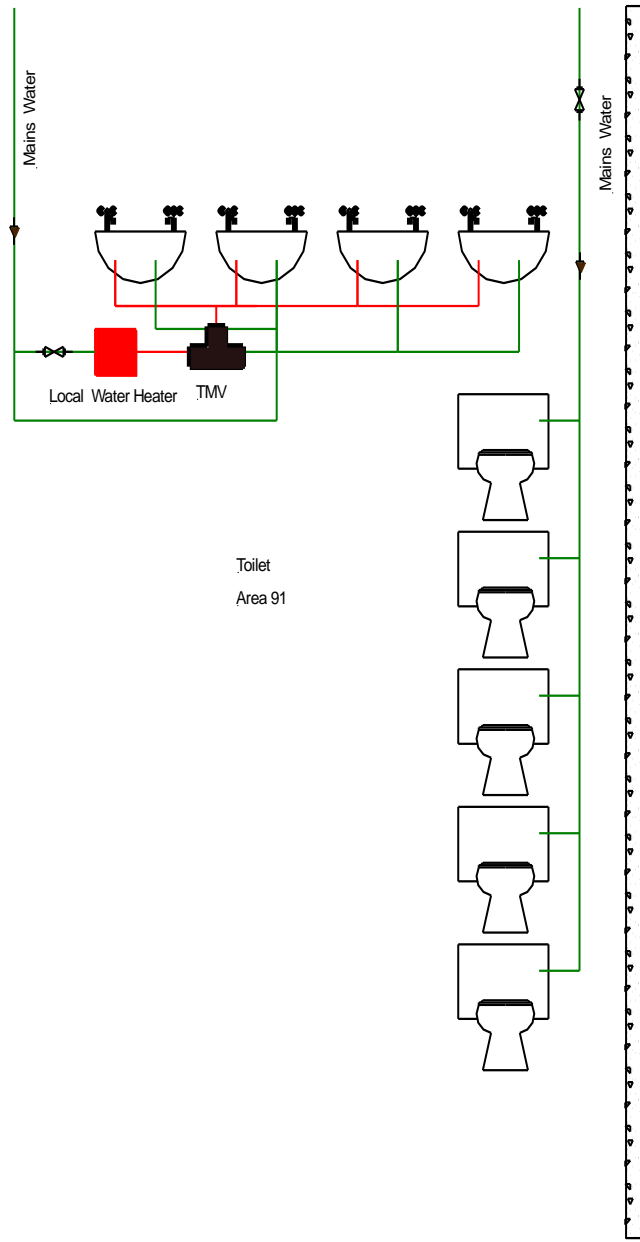
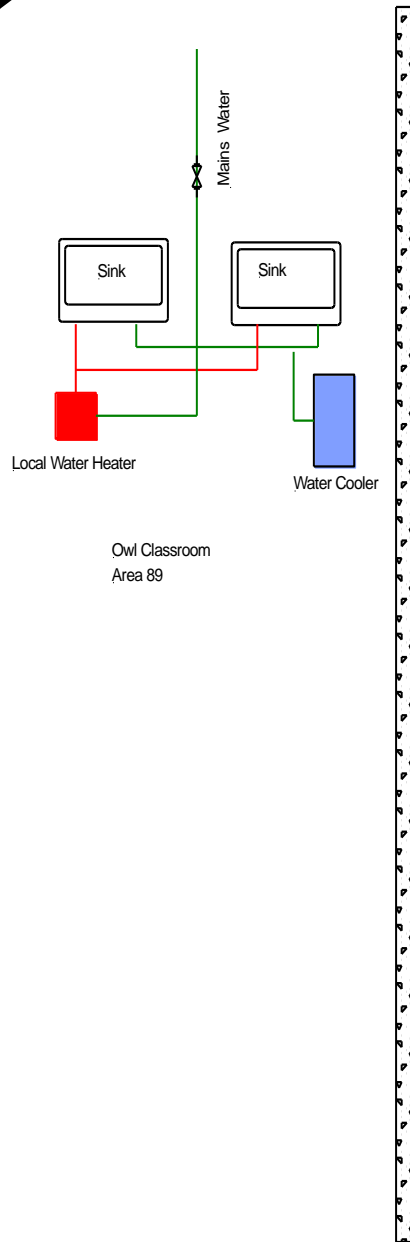
Drawing No.10



### KEY

-  Ball A Fix Valve
-  bf
-  Check Valve
-  Laboratory Tap
-  Blender Valve
-  Pump
-  Isolating Valve
-  Safety Valve
-  Drinking Fountain
-  Shower
-  Mains Water Service
-  Cold Water Down Service
-  Hot Flow/Return

**Note**  
 This drawing was prepared for the Legionellosis Risk Assessment Report and not intended as a scaled system drawing. Drawings are based on a visual inspection carried out during the Risk Assessment and information given at the time of the survey. Some areas of pipe work may not have been visible during the survey therefore some assumptions may have been made in order to create this drawing. This drawing is not to scale.

*Freeston Water Treatment  
 Unit 1  
 Lulworth Business Centre  
 Calmore Industrial Estate  
 Totton Southampton  
 SO40 3WW  
 Tel 02380669713*

Site Ref  
 Maytree Infants School  
 New Classroom

Date 31st July 2017

Drawing No.11