

Sinclair Primary School
Water System Drawings
6th January 2017

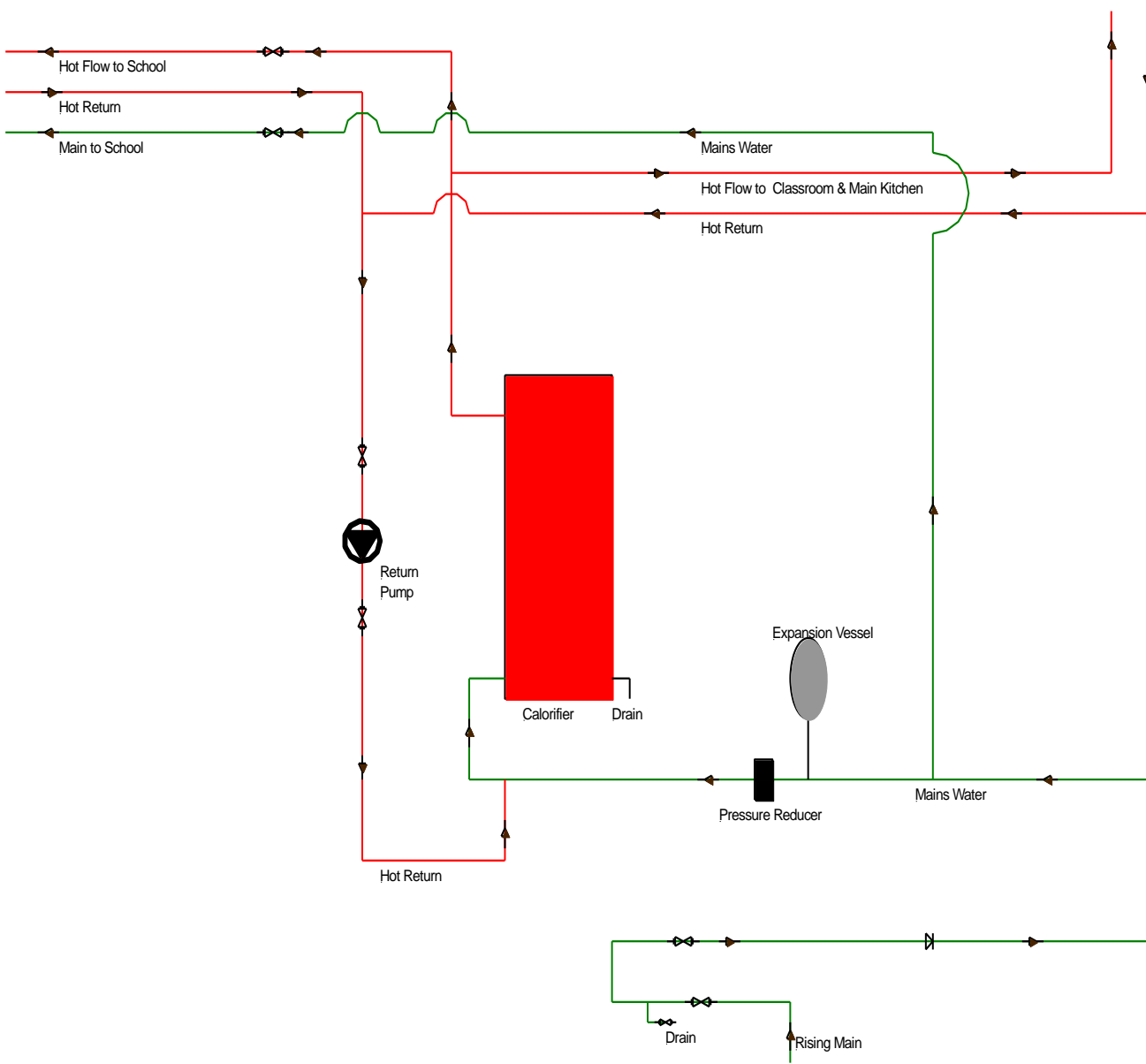

KEY

- Ball A Fix Valve
- bf
- Check Valve
- Laboratory Tap
- Blender Valve
- Pump
- Isolating Valve
- Safety Valve
- Drinking Fountain
- Shower
- Mains Water Service
- Cold Water Down Service
- Hot Flow/Return

Note
 This drawing was prepared for the Legionellosis Risk Assessment Report and not intended as a scaled system drawing.
 Drawings are based on a visual inspection carried out during the Risk Assessment and information given at the time of the survey.
 Some areas of pipe work may not have been visible during the survey therefore some assumptions may have been made in order to create this drawing.
 This drawing is not to scale.

*Freeston Water Treatment
 Unit 1
 Lulworth Business Centre
 Calmore Industrial Estate
 Totton Southampton
 SO40 3WW
 Tel 02380669713*

Site Ref
 Sinclair Primary School
 Boiler Room

Date 6th January 2017

Drawing No.1

Old Toilet & Shower Room Being Refurbished at the time of this 2017 review

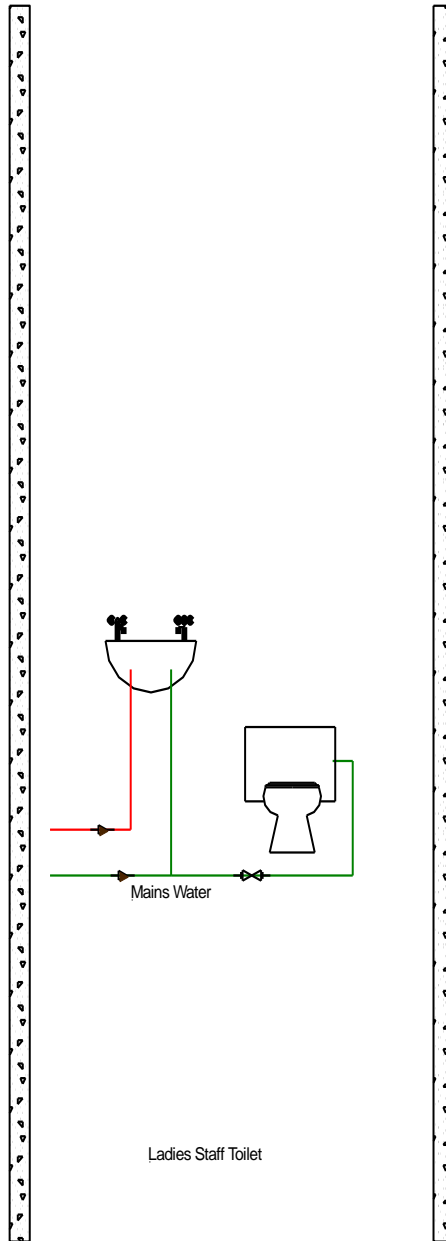

Ladies Staff Toilet

Kitchen

KEY

-  Ball A Fix Valve
-  bf
-  Check Valve
-  Laboratory Tap
-  Blender Valve
-  Pump
-  Isolating Valve
-  Safety Valve
-  Drinking Fountain
-  Shower
-  Mains Water Service
-  Cold Water Down Service
-  Hot Flow/Return

Note

This drawing was prepared for the Legionellosis Risk Assessment Report and not intended as a scaled system drawing. Drawings are based on a visual inspection carried out during the Risk Assessment and information given at the time of the survey. Some areas of pipe work may not have been visible during the survey therefore some assumptions may have been made in order to create this drawing. This drawing is not to scale.

*Freeston Water Treatment
Unit 1
Lulworth Business Centre
Calmore Industrial Estate
Totton Southampton
SO40 3WW
Tel 02380669713*

Site Ref
Sinclair Primary School
Reception Area
Staff Toilets
Office
Date 6th January 2017

Drawing No.2

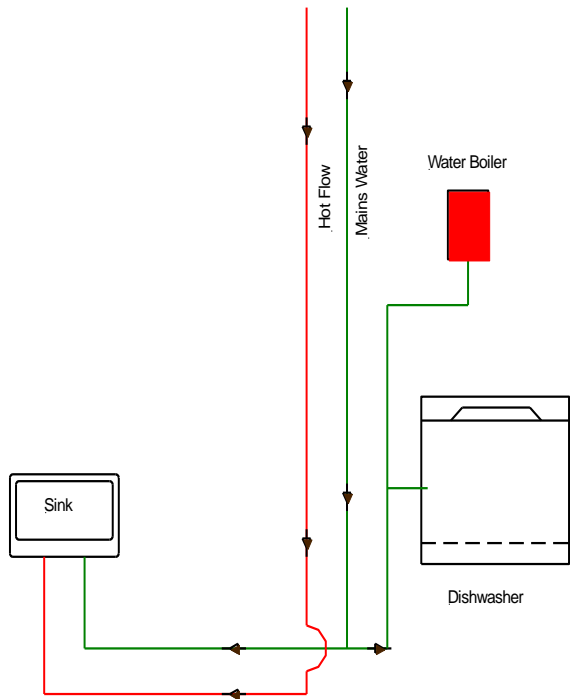

Staff Room Area

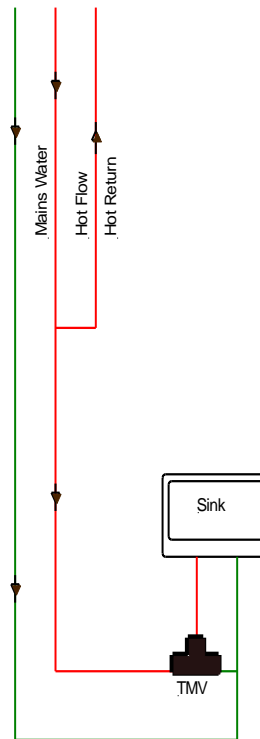

Year 5 Classroom

KEY

-  Ball A Fix Valve
-  bf
-  Check Valve
-  Laboratory Tap
-  Blender Valve
-  Pump
-  Isolating Valve
-  Safety Valve
-  Drinking Fountain
-  Shower
-  Mains Water Service
-  Cold Water Down Service
-  Hot Flow/Return

Note

This drawing was prepared for the Legionellosis Risk Assessment Report and not intended as a scaled system drawing.

Drawings are based on a visual inspection carried out during the Risk Assessment and information given at the time of the survey.

Some areas of pipe work may not have been visible during the survey therefore some assumptions may have been made in order to create this drawing.

This drawing is not to scale.

*Freeston Water Treatment
Unit 1
Lulworth Business Centre
Calmore Industrial Estate
Totton Southampton
SO40 3WW
Tel 02380669713*

Site Ref
Sinclair Primary School
Staff Room Area
Year 5 Classroom

Date 6th January 2017

Drawing No.3

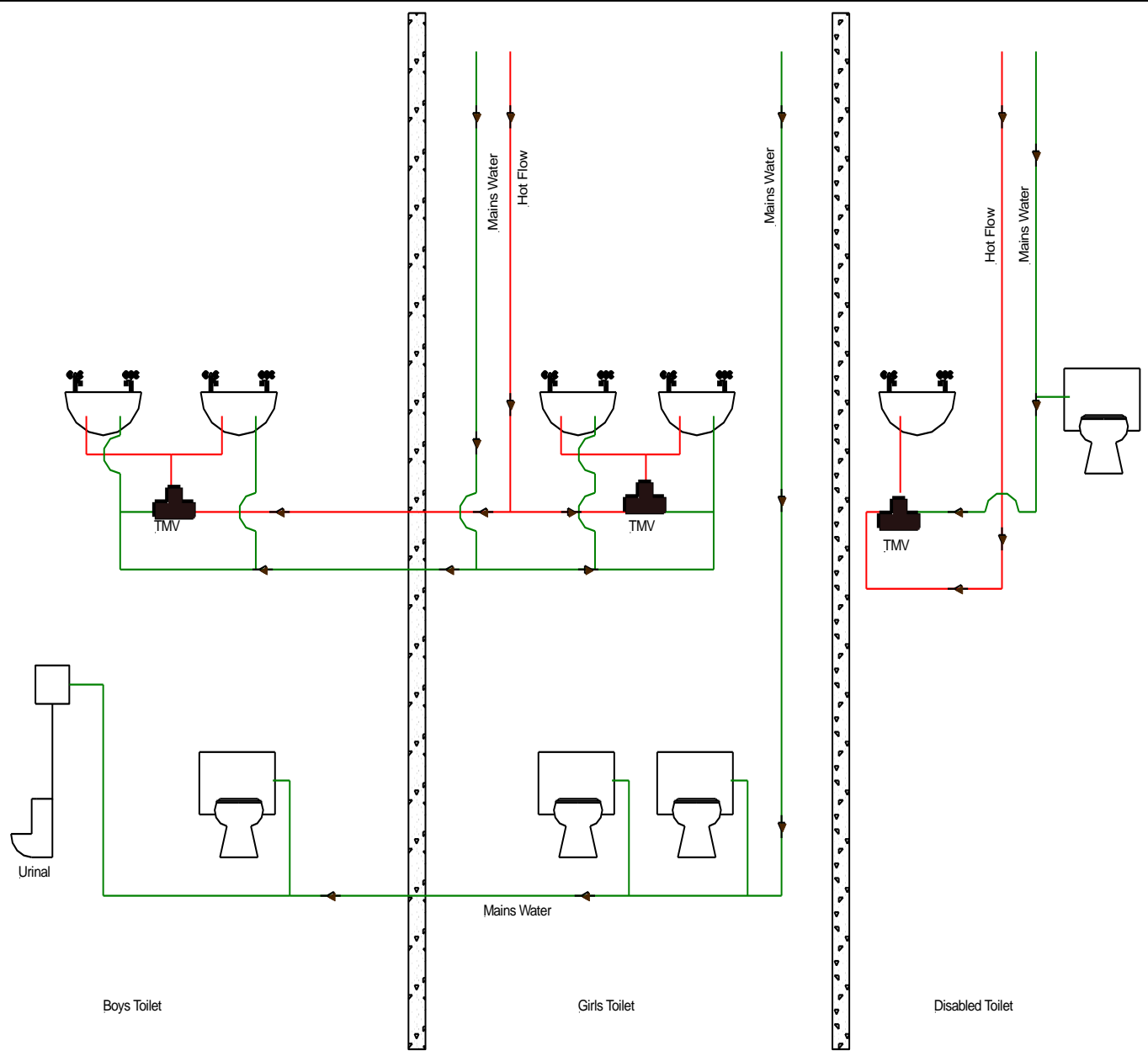

KEY

- Ball A Fix Valve
- bf
- Check Valve
- Laboratory Tap
- Blender Valve
- Pump
- Isolating Valve
- Safety Valve
- Drinking Fountain
- Shower
- Mains Water Service
- Cold Water Down Service
- Hot Flow/Return

Note
 This drawing was prepared for the Legionellosis Risk Assessment Report and not intended as a scaled system drawing. Drawings are based on a visual inspection carried out during the Risk Assessment and information given at the time of the survey. Some areas of pipe work may not have been visible during the survey therefore some assumptions may have been made in order to create this drawing. This drawing is not to scale.

*Freeston Water Treatment
 Unit 1
 Lulworth Business Centre
 Calmore Industrial Estate
 Totton Southampton
 SO40 3WW
 Tel 02380669713*

Site Ref
 Sinclair Primary School
 Year 5 Toilets
 Disabled Toilet

Date 6th January 2017

Drawing No.4

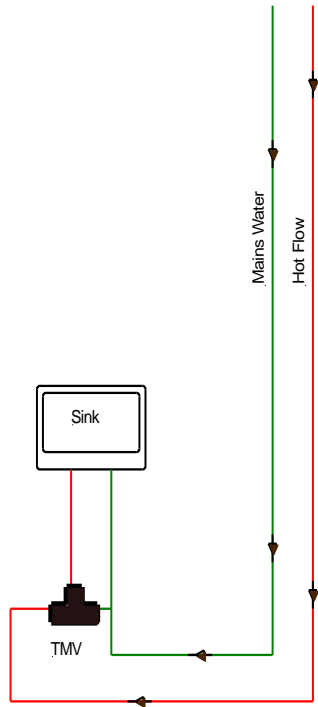

Year 6 Classroom

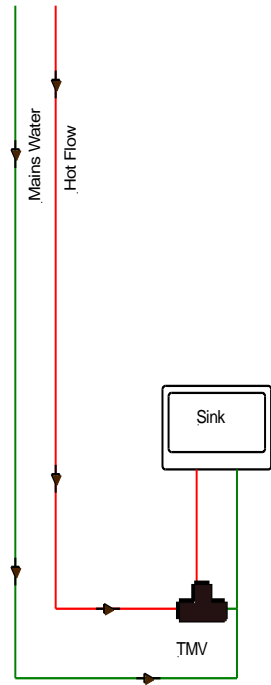

Year 3 Classroom

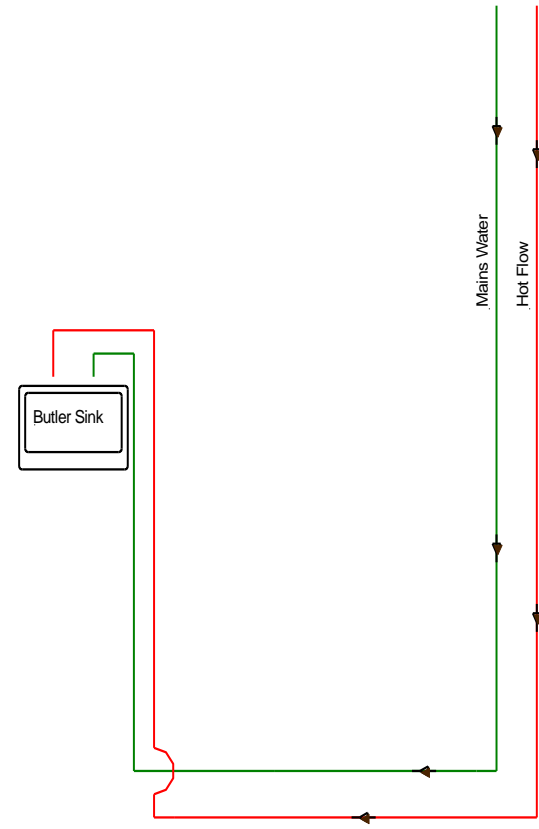

Cleaners Room (Old Toilet)

KEY

- Ball A Fix Valve
- bf
- Check Valve
- Laboratory Tap
- Blender Valve
- Pump
- Isolating Valve
- Safety Valve
- Drinking Fountain
- Shower
- Mains Water Service
- Cold Water Down Service
- Hot Flow/Return

Note
 This drawing was prepared for the Legionellosis Risk Assessment Report and not intended as a sealed system drawing. Drawings are based on a visual inspection carried out during the Risk Assessment and information given at the time of the survey. Some areas of pipe work may not have been visible during the survey therefore some assumptions may have been made in order to create this drawing.
 This drawing is not to scale.

*Freeston Water Treatment
 Unit 1
 Lulworth Business Centre
 Calmore Industrial Estate
 Totton Southampton
 SO40 3WW
 Tel 02380669713*

Site Ref
 Sinclair Primary School
 Year 6W Classroom
 Year 4 Classroom
 Cleaners Room
 Date 6th January 2017

Drawing No.5

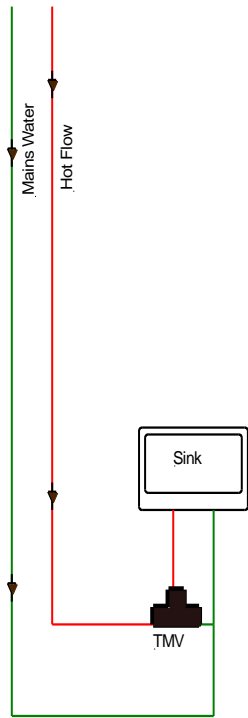

Year 3 Classroom

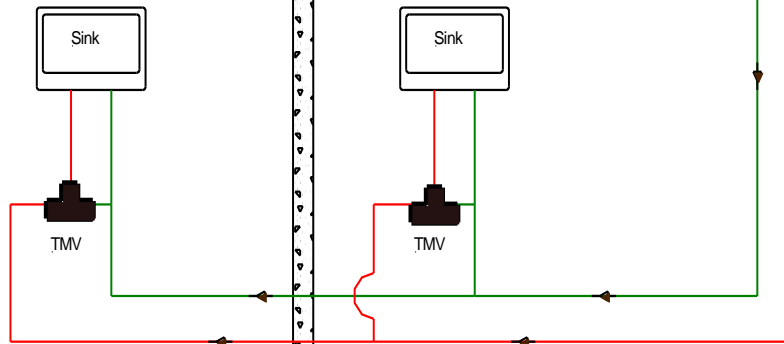

Year 4 Classroom

Site Managers Office

KEY

-  Ball A Fix Valve
-  bf
-  Check Valve
-  Laboratory Tap
-  Blender Valve
-  Pump
-  Isolating Valve
-  Safety Valve
-  Drinking Fountain
-  Shower
-  Mains Water Service
-  Cold Water Down Service
-  Hot Flow/Return

Note

This drawing was prepared for the Legionellosis Risk Assessment Report and not intended as a scaled system drawing. Drawings are based on a visual inspection carried out during the Risk Assessment and information given at the time of the survey. Some areas of pipe work may not have been visible during the survey therefore some assumptions may have been made in order to create this drawing.

This drawing is not to scale.

*Freeston Water Treatment
Unit 1
Lulworth Business Centre
Calmore Industrial Estate
Totton Southampton
SO40 3WW
Tel 02380669713*

Site Ref
Sinclair Primary School
Year 2 Classroom
Year 3 Classroom
Parents Room
Date 6th January 2017

Drawing No.6

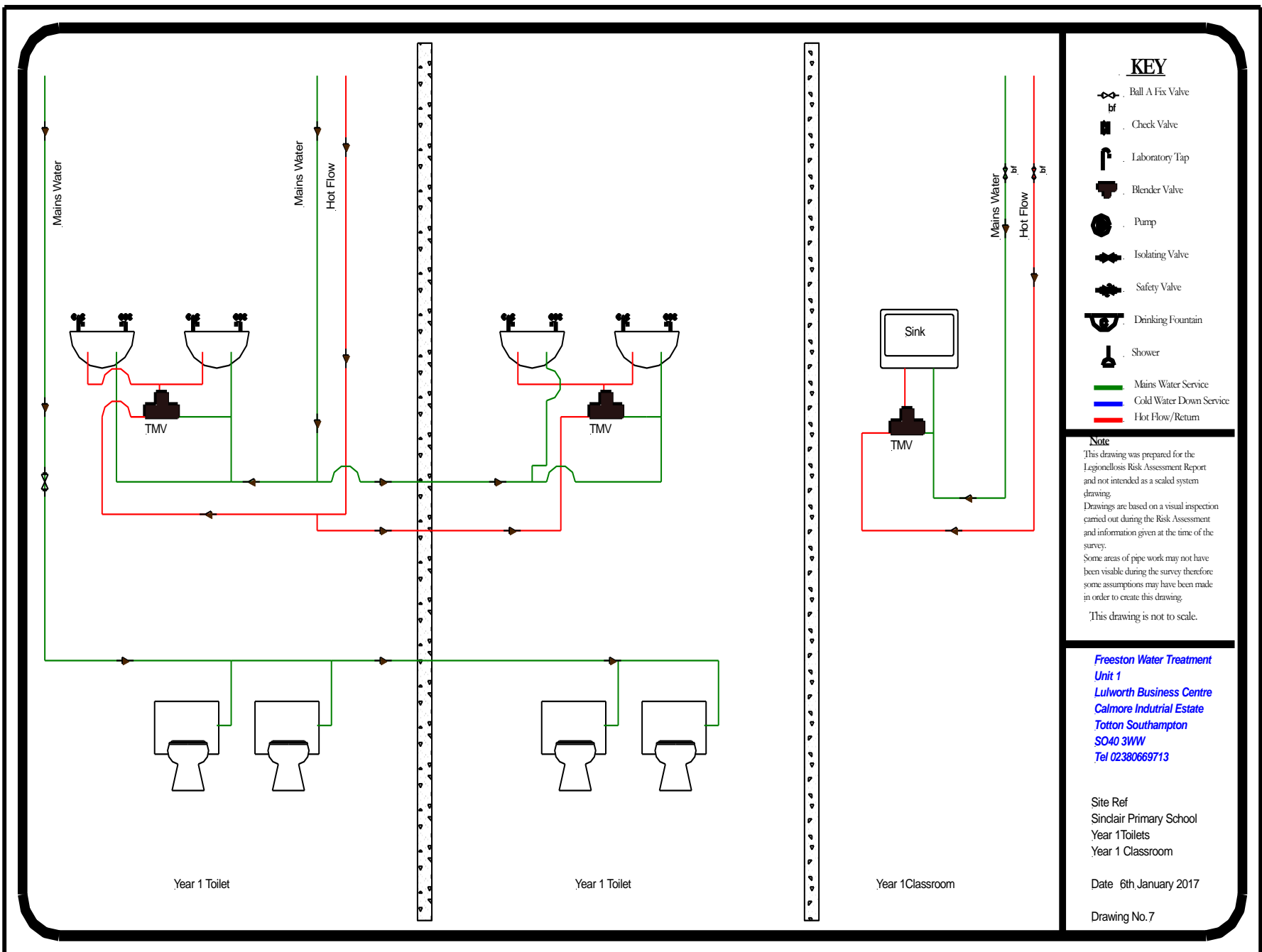

KEY

-  Ball A Fix Valve
-  bf
-  Check Valve
-  Laboratory Tap
-  Blender Valve
-  Pump
-  Isolating Valve
-  Safety Valve
-  Drinking Fountain
-  Shower
-  Mains Water Service
-  Cold Water Down Service
-  Hot Flow/Return

Note

This drawing was prepared for the Legionellosis Risk Assessment Report and not intended as a scaled system drawing. Drawings are based on a visual inspection carried out during the Risk Assessment and information given at the time of the survey. Some areas of pipe work may not have been visible during the survey therefore some assumptions may have been made in order to create this drawing. This drawing is not to scale.

*Freeston Water Treatment
Unit 1
Lulworth Business Centre
Calmore Industrial Estate
Totton Southampton
SO40 3WW
Tel 02380669713*

Site Ref
Sinclair Primary School
Year 1 Toilets
Year 1 Classroom

Date 6th January 2017

Drawing No.7

Year 1 Toilet

Year 1 Toilet

Year 1 Classroom

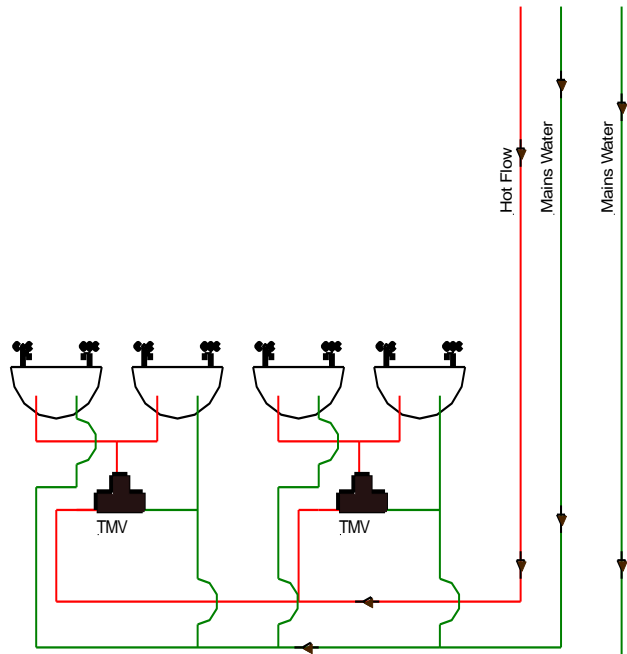

Year 2 & 3 Boys Toilet

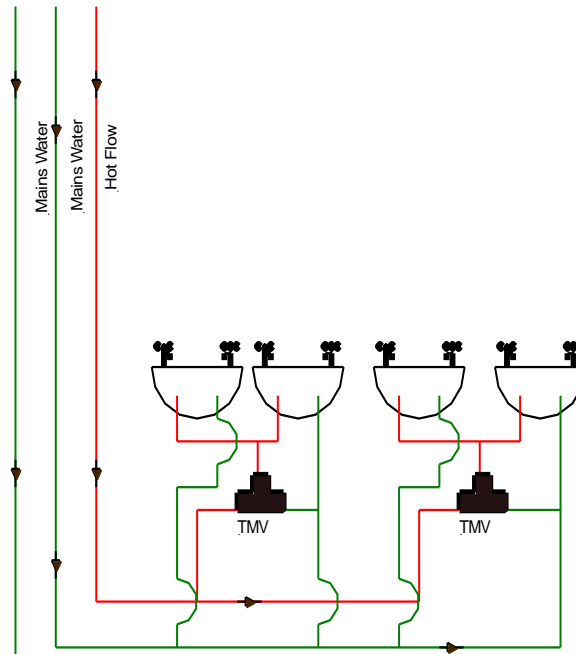

Year 2 & 3 Girls Toilet

KEY

-  Ball A Fix Valve
-  bf
-  Check Valve
-  Laboratory Tap
-  Blender Valve
-  Pump
-  Isolating Valve
-  Safety Valve
-  Drinking Fountain
-  Shower
-  Mains Water Service
-  Cold Water Down Service
-  Hot Flow/Return

Note
 This drawing was prepared for the Legionellosis Risk Assessment Report and not intended as a scaled system drawing. Drawings are based on a visual inspection carried out during the Risk Assessment and information given at the time of the survey. Some areas of pipe work may not have been visible during the survey therefore some assumptions may have been made in order to create this drawing. This drawing is not to scale.

*Freeston Water Treatment Unit 1
 Lulworth Business Centre
 Calmore Industrial Estate
 Totton Southampton
 SO40 3WW
 Tel 02380669713*







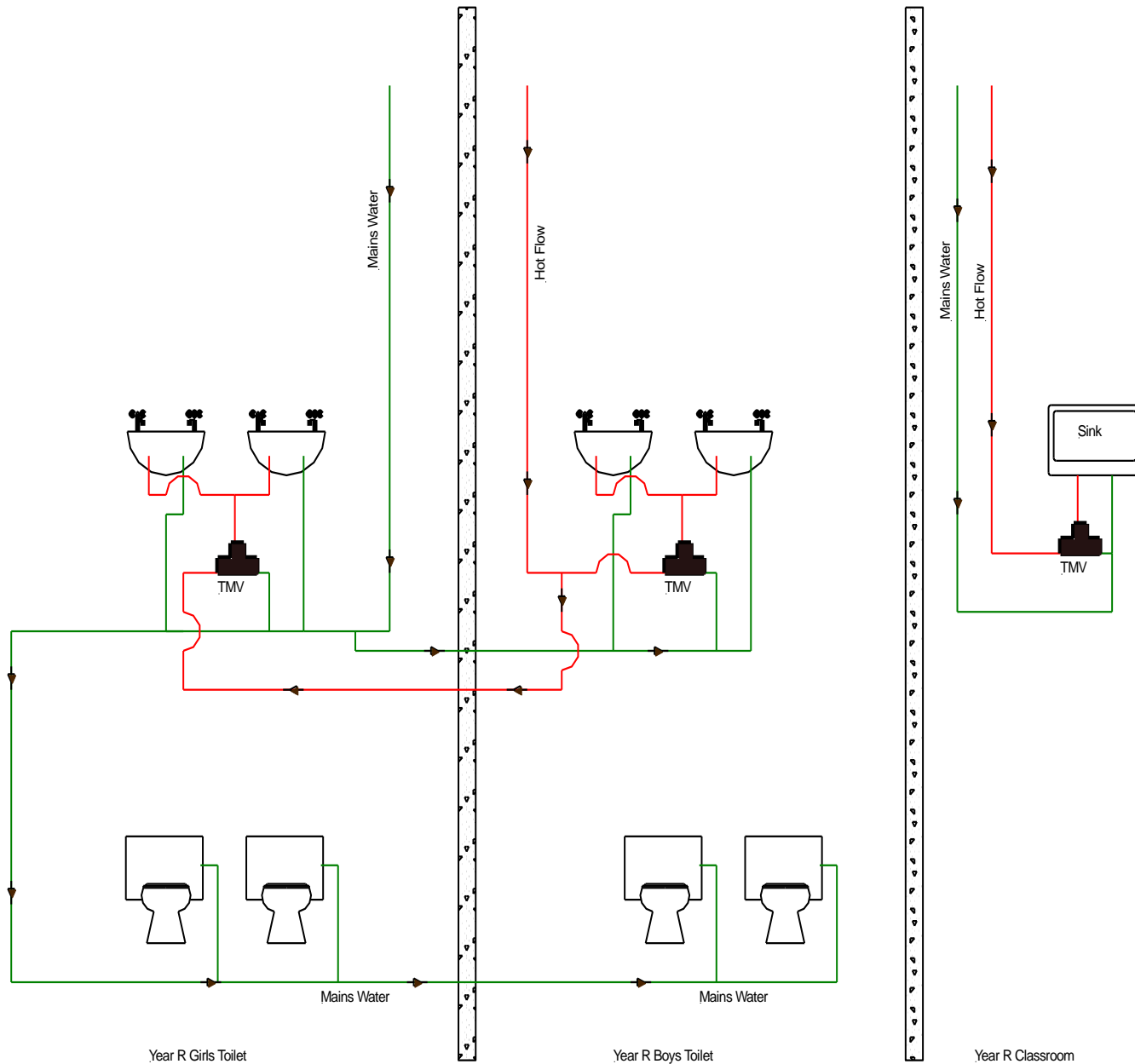





Site Ref
 Sinclair Primary School
 Boys Toilet
 Girls Toilet

Date 6th January 2017

Drawing No.8



KEY

-  Ball A Fix Valve
-  bf
-  Check Valve
-  Laboratory Tap
-  Blender Valve
-  Pump
-  Isolating Valve
-  Safety Valve
-  Drinking Fountain
-  Shower
-  Mains Water Service
-  Cold Water Down Service
-  Hot Flow/Return

Note

This drawing was prepared for the Legionellosis Risk Assessment Report and not intended as a scaled system drawing. Drawings are based on a visual inspection carried out during the Risk Assessment and information given at the time of the survey. Some areas of pipe work may not have been visible during the survey therefore some assumptions may have been made in order to create this drawing.

This drawing is not to scale.

*Freeston Water Treatment
Unit 1
Lulworth Business Centre
Calmore Industrial Estate
Totton Southampton
SO40 3WW
Tel 02380669713*

Site Ref
Sinclair Primary School
Year R Toilets & Classroom

Date 6th January 2017

Drawing No.9

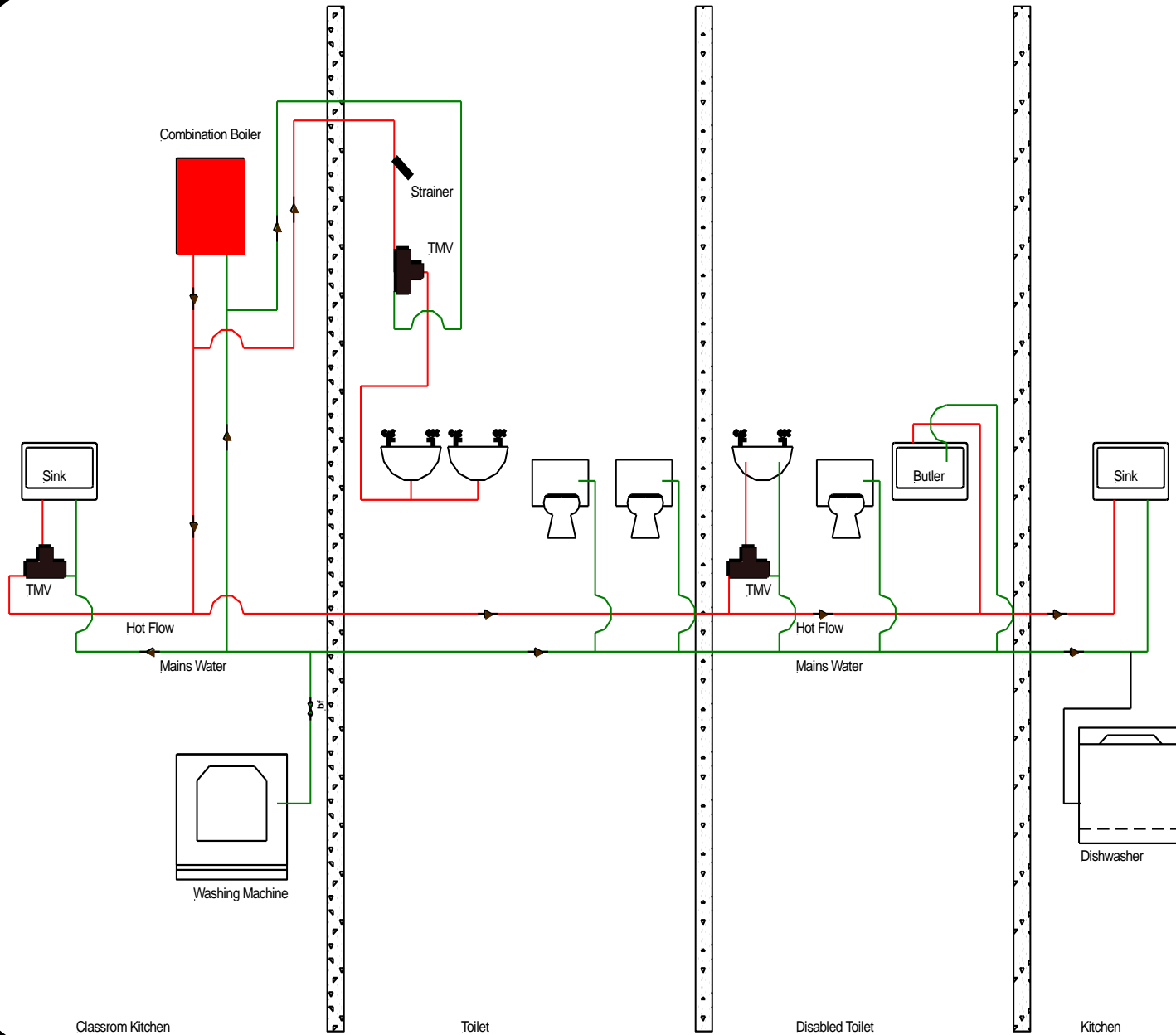

KEY

- Ball A Fix Valve
- bf
- Check Valve
- Laboratory Tap
- Blender Valve
- Pump
- Isolating Valve
- Safety Valve
- Drinking Fountain
- Shower
- Mains Water Service
- Cold Water Down Service
- Hot Flow/Return

Note

This drawing was prepared for the Legionellosis Risk Assessment Report and not intended as a scaled system drawing. Drawings are based on a visual inspection carried out during the Risk Assessment and information given at the time of the survey. Some areas of pipe work may not have been visible during the survey therefore some assumptions may have been made in order to create this drawing. This drawing is not to scale.

*Freeston Water Treatment
Unit 1
Lulworth Business Centre
Calmore Industrial Estate
Totton Southampton
SO40 3WW
Tel 02380669713*

Site Ref
Sinclair Primary School
Nursery Area

Date 6th January 2017

Drawing No.10

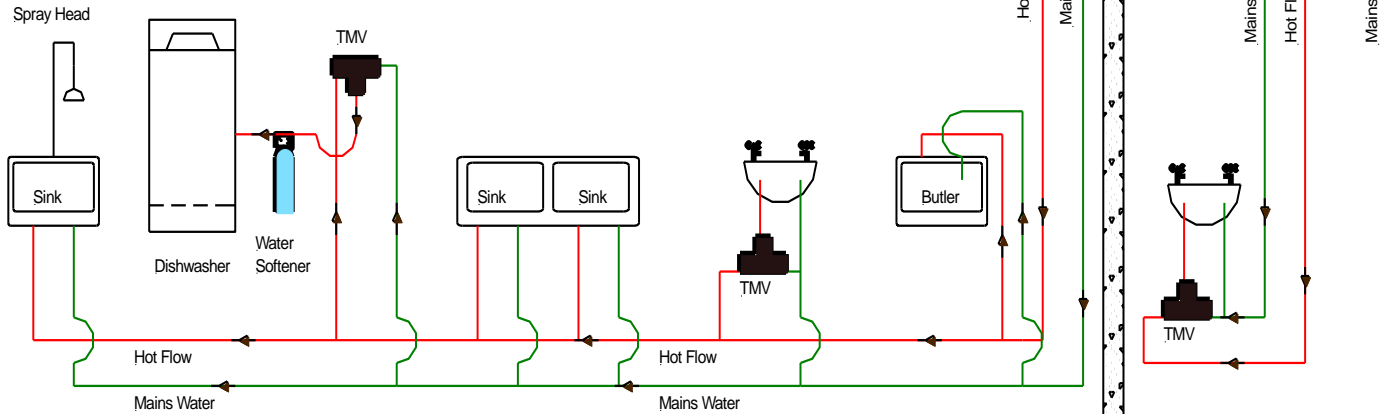

Main Kitchen

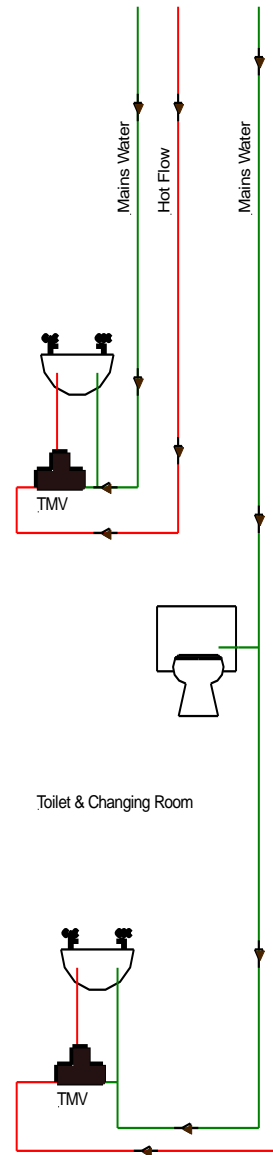
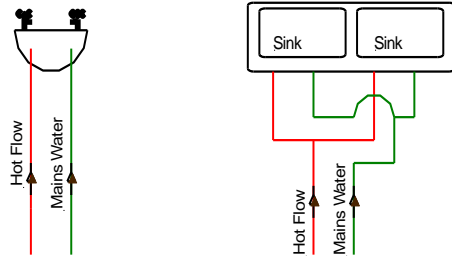

Toilet & Changing Room

KEY

- Ball A Fix Valve
- bf
- Check Valve
- Laboratory Tap
- Blender Valve
- Pump
- Isolating Valve
- Safety Valve
- Drinking Fountain
- Shower
- Mains Water Service
- Cold Water Down Service
- Hot Flow/Return

Note

This drawing was prepared for the Legionellosis Risk Assessment Report and not intended as a scaled system drawing. Drawings are based on a visual inspection carried out during the Risk Assessment and information given at the time of the survey. Some areas of pipe work may not have been visible during the survey therefore some assumptions may have been made in order to create this drawing. This drawing is not to scale.

*Freeston Water Treatment
Unit 1
Lulworth Business Centre
Calmore Industrial Estate
Totton Southampton
SO40 3WW
Tel 02380669713*

Site Ref
Sinclair Primary School
Main Kitchen Area

Date 6th January 2017

Drawing No.11