

**Sholing Technology College**

**Water System Drawings**

**31<sup>st</sup> May 2018**

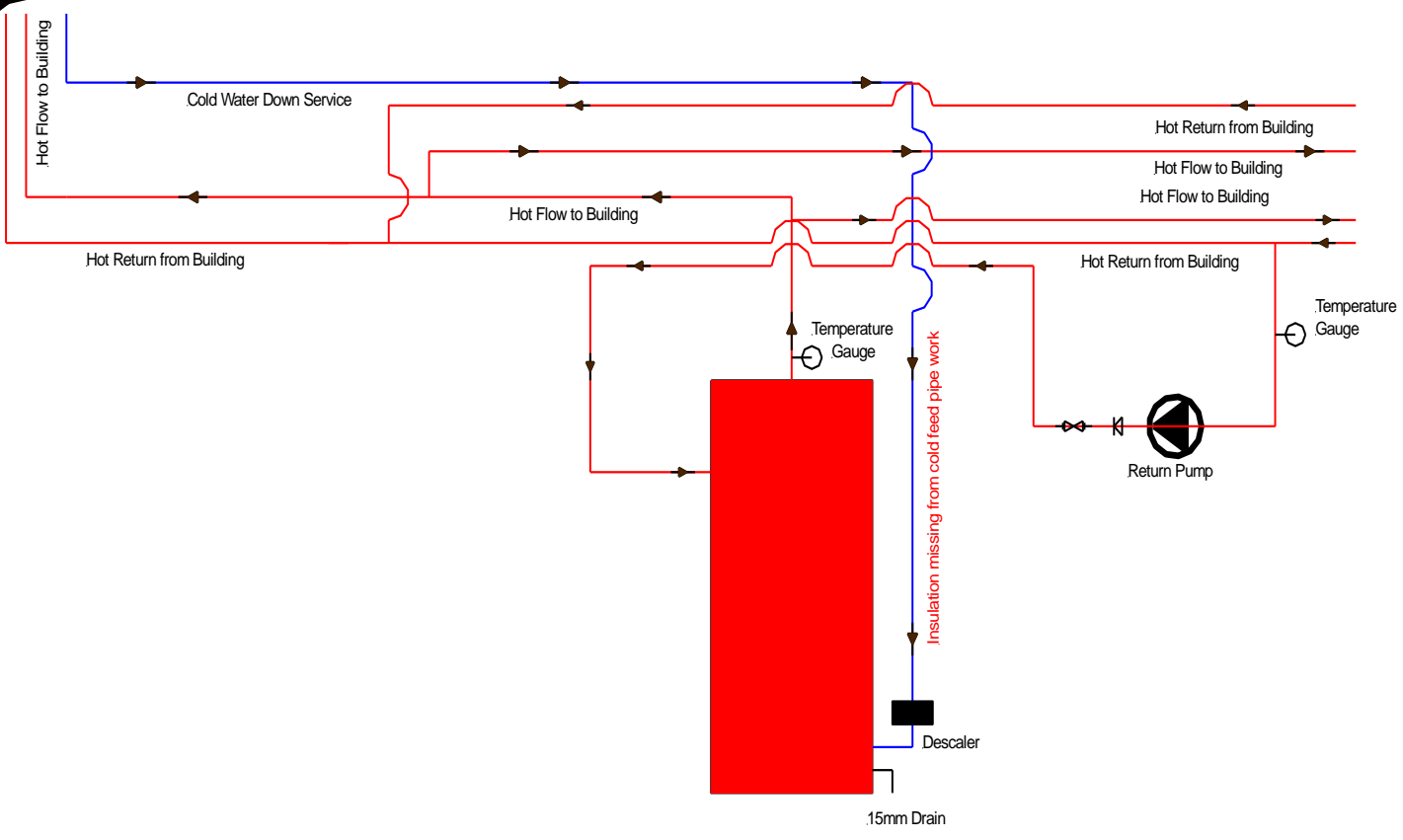

**KEY**

- Ball A Fix Valve
- Check Valve
- Laboratory Tap
- Blender Valve
- Pump
- Isolating Valve
- Safety Valve
- Drinking Fountain
- Shower
- Mains Water Service
- Cold Water Down Service
- Hot Flow/Return

**Note**

This drawing was prepared for the Legionellosis Risk Assessment Report and not intended as a scaled system drawing. Drawings are based on a visual inspection carried out during the Risk Assessment and information given at the time of the survey. Some areas of pipe work may not have been visible during the survey therefore some assumptions may have been made in order to create this drawing. This drawing is not to scale.

*Freeston Water Treatment  
Unit 1  
Lulworth Business Centre  
Calmore Industrial Estate  
Totton Southampton  
SO40 3WW  
Tel 02380669713*

Site Ref  
Sholing Technology College  
Main Building Plant Room  
Calorifier

Date 31st May 2018

Drawing No.1

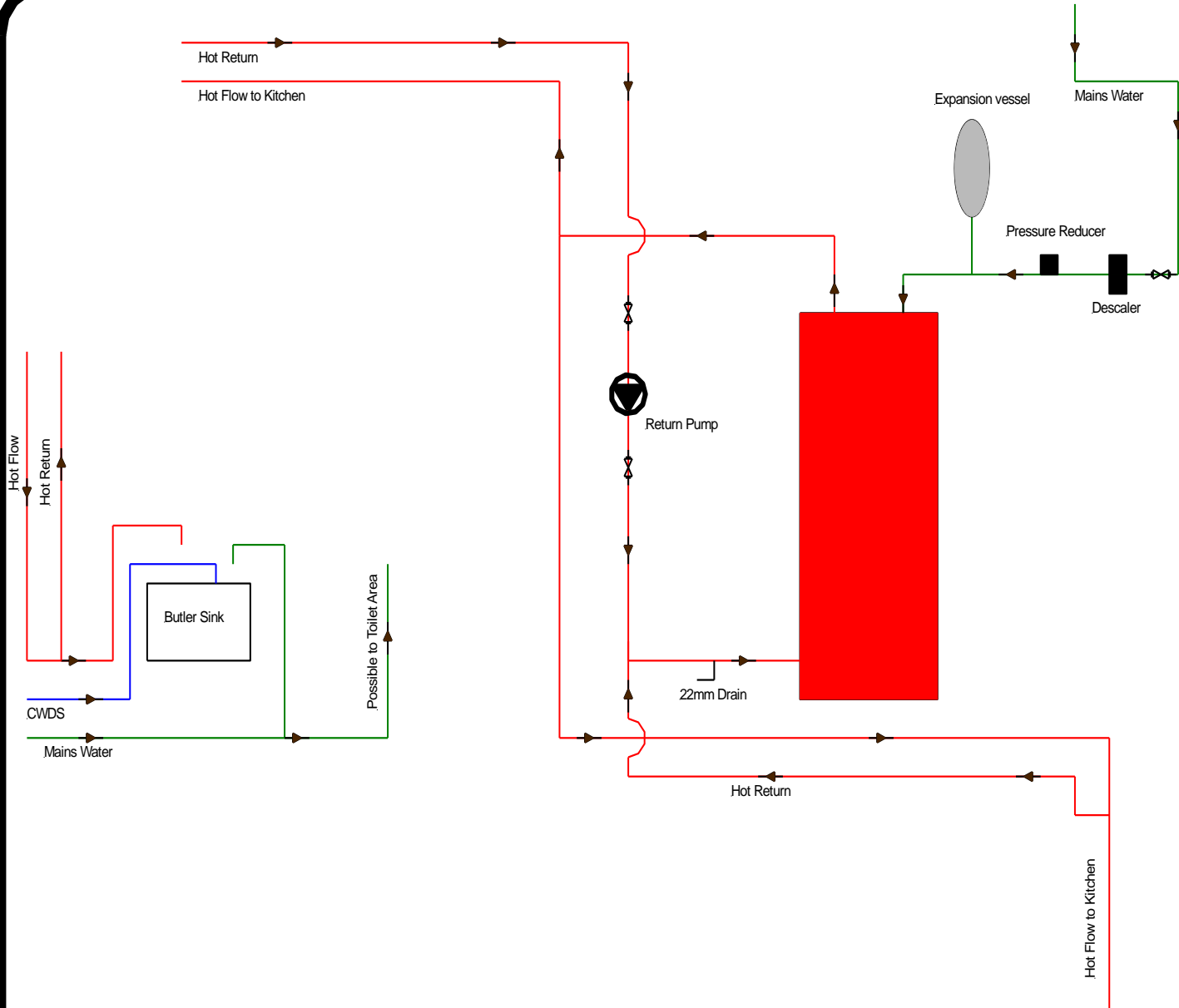

**KEY**

- Ball A Fix Valve
- bf
- Check Valve
- Laboratory Tap
- Blender Valve
- Pump
- Isolating Valve
- Safety Valve
- Drinking Fountain
- Shower
- Mains Water Service
- Cold Water Down Service
- Hot Flow/Return

**Note**

This drawing was prepared for the Legionellosis Risk Assessment Report and not intended as a scaled system drawing. Drawings are based on a visual inspection carried out during the Risk Assessment and information given at the time of the survey. Some areas of pipe work may not have been visible during the survey therefore some assumptions may have been made in order to create this drawing. This drawing is not to scale.

*Freeston Water Treatment Unit 1  
Lulworth Business Centre  
Calmore Industrial Estate  
Totton Southampton  
SO40 3WW  
Tel 02380669713*

Site Ref  
Sholing Technology College  
Main Building  
Kitchen & Toilet Calorifier Room

Date 31st May 2018

Drawing No.2

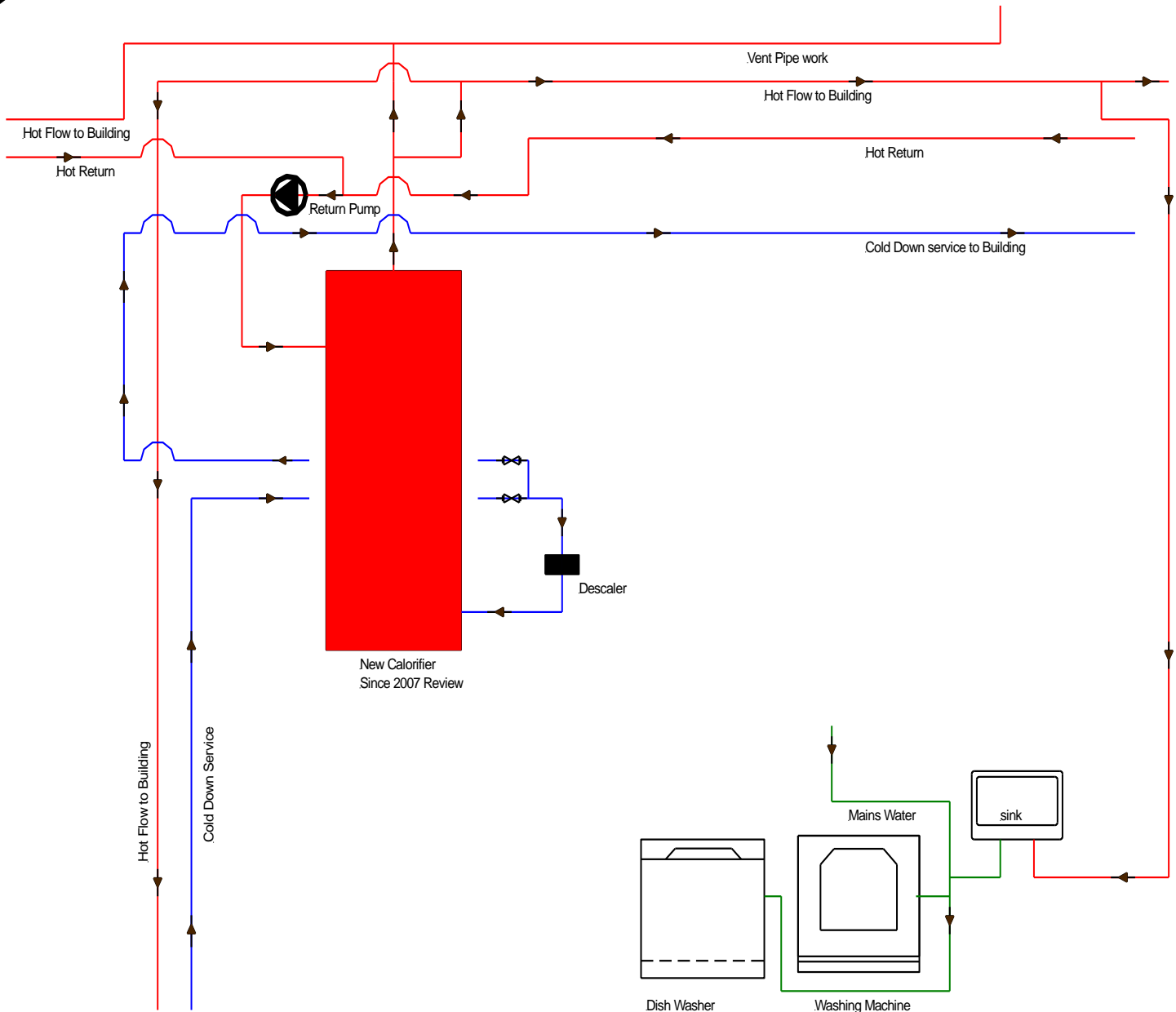

**KEY**

- Ball A Fix Valve
- bf
- Check Valve
- Laboratory Tap
- Blender Valve
- Pump
- Isolating Valve
- Safety Valve
- Drinking Fountain
- Shower
- Mains Water Service
- Cold Water Down Service
- Hot Flow/Return

**Note**

This drawing was prepared for the Legionellosis Risk Assessment Report and not intended as a scaled system drawing. Drawings are based on a visual inspection carried out during the Risk Assessment and information given at the time of the survey. Some areas of pipe work may not have been visible during the survey therefore some assumptions may have been made in order to create this drawing. This drawing is not to scale.

*Freeston Water Treatment Unit 1  
Lulworth Business Centre  
Calmore Industrial Estate  
Totton Southampton  
SO40 3WW  
Tel 02380669713*

Site Ref  
Sholing Technical College  
Main Building Old Caretakers  
Room Calorifier

Date 31st May 2018

Drawing No.3

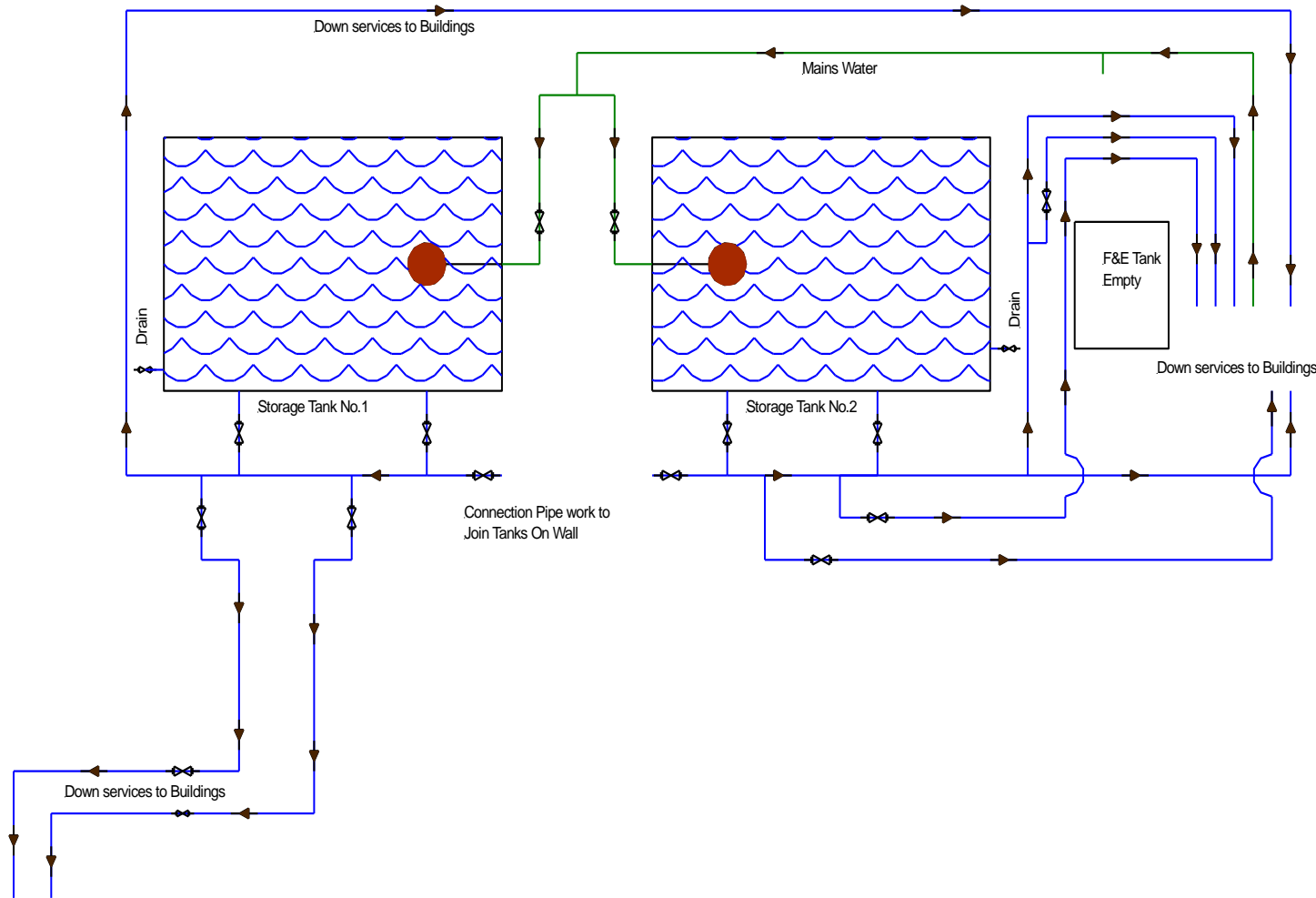

### KEY

- Ball A Fix Valve
- bf
- Check Valve
- Laboratory Tap
- Blender Valve
- Pump
- Isolating Valve
- Safety Valve
- Drinking Fountain
- Shower
- Mains Water Service
- Cold Water Down Service
- Hot Flow/Return

### Note

This drawing was prepared for the Legionellosis Risk Assessment Report and not intended as a scaled system drawing. Drawings are based on a visual inspection carried out during the Risk Assessment and information given at the time of the survey. Some areas of pipe work may not have been visible during the survey therefore some assumptions may have been made in order to create this drawing. This drawing is not to scale.

**Freeston Water Treatment Unit 1**  
**Lulworth Business Centre**  
**Calmore Industrial Estate**  
**Totton Southampton**  
**SO40 3WW**  
**Tel 02380669713**

Site Ref  
 Sholing Technical College  
 Main Building Tank Room

Date 31st May 2018

Drawing No.4

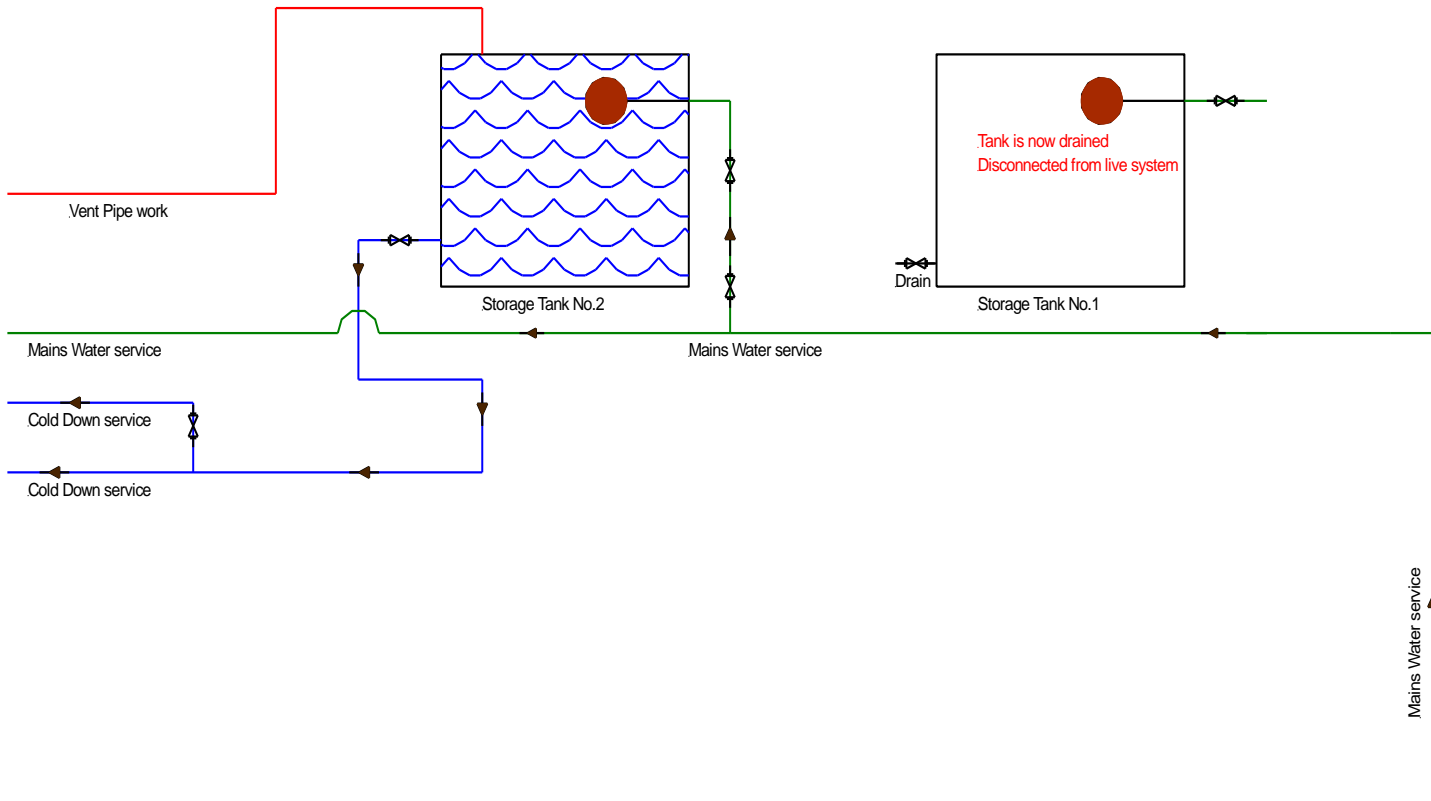

**KEY**

- Ball A Fix Valve
- bf
- Check Valve
- Laboratory Tap
- Blender Valve
- Pump
- Isolating Valve
- Safety Valve
- Drinking Fountain
- Shower
- Mains Water Service
- Cold Water Down Service
- Hot Flow/Return

**Note**

This drawing was prepared for the Legionellosis Risk Assessment Report and not intended as a scaled system drawing. Drawings are based on a visual inspection carried out during the Risk Assessment and information given at the time of the survey. Some areas of pipe work may not have been visible during the survey therefore some assumptions may have been made in order to create this drawing. This drawing is not to scale.

**Freeston Water Treatment Unit 1**  
**Lulworth Business Centre**  
**Calmore Industrial Estate**  
**Totton Southampton**  
**SO40 3WW**  
**Tel 02380669713**

Site Ref  
 Sholing Technology College  
 Science Block Storage Tanks  
 Roof Space

Date 31st May 2018

Drawing No.5

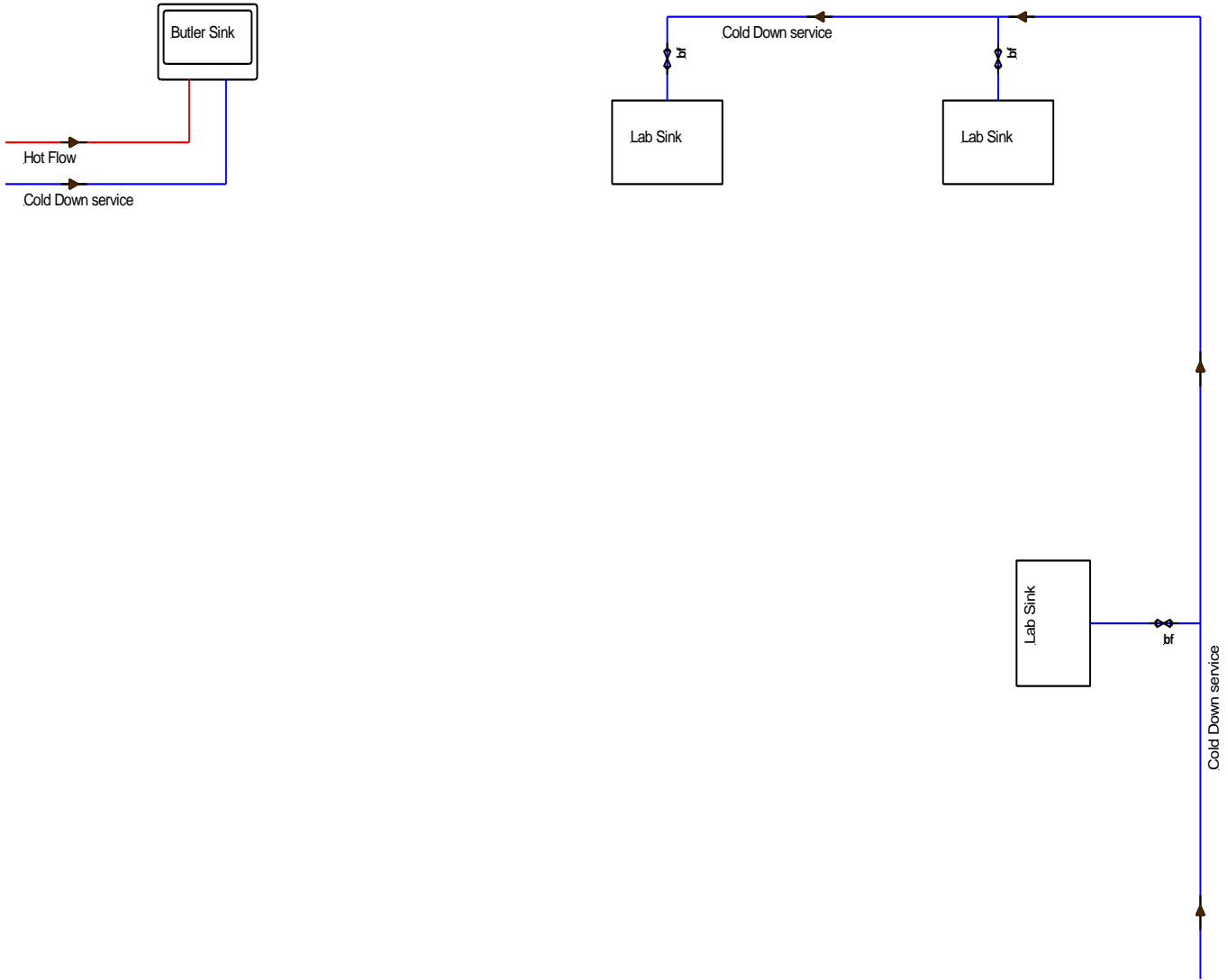

**KEY**

-  Ball A Fix Valve
-  bf
-  Check Valve
-  Laboratory Tap
-  Blender Valve
-  Pump
-  Isolating Valve
-  Safety Valve
-  Drinking Fountain
-  Shower
-  Mains Water Service
-  Cold Water Down Service
-  Hot Flow/Return

**Note**

This drawing was prepared for the Legionellosis Risk Assessment Report and not intended as a scaled system drawing. Drawings are based on a visual inspection carried out during the Risk Assessment and information given at the time of the survey. Some areas of pipe work may not have been visible during the survey therefore some assumptions may have been made in order to create this drawing. This drawing is not to scale.

*Freeston Water Treatment Unit 1  
Lulworth Business Centre  
Calmore Industrial Estate  
Totton Southampton  
SO40 3WW  
Tel 02380669713*

Site Ref  
Sholing Technical College  
Science Block 1st Floor  
Laboratory 1

Date 31st May 2018

Drawing No.6

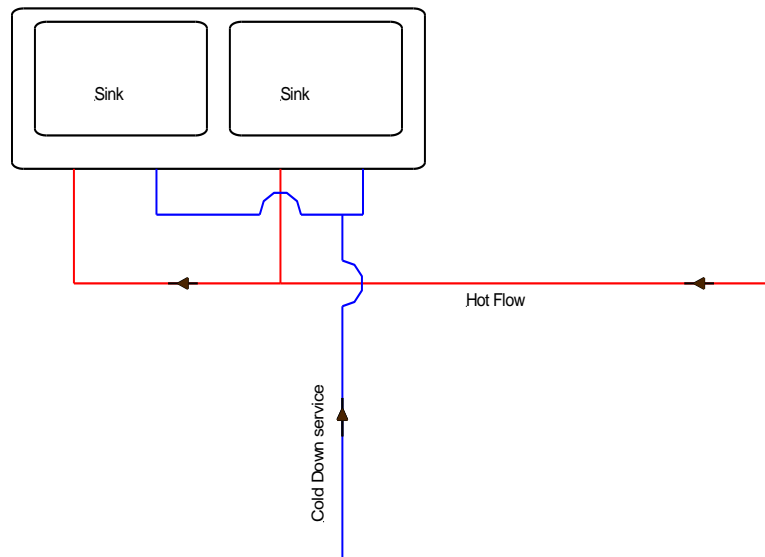

### KEY

-  Ball A Fix Valve
-  Check Valve
-  Laboratory Tap
-  Blender Valve
-  Pump
-  Isolating Valve
-  Safety Valve
-  Drinking Fountain
-  Shower
-  Mains Water Service
-  Cold Water Down Service
-  Hot Flow/Return

### Note

This drawing was prepared for the Legionellosis Risk Assessment Report and not intended as a scaled system drawing.  
 Drawings are based on a visual inspection carried out during the Risk Assessment and information given at the time of the survey.  
 Some areas of pipe work may not have been visible during the survey therefore some assumptions may have been made in order to create this drawing.  
 This drawing is not to scale.

*Freeston Water Treatment  
 Unit 1  
 Lulworth Business Centre  
 Calmore Industrial Estate  
 Totton Southampton  
 SO40 3WW  
 Tel 02380669713*

Site Ref  
 Sholing Technical College  
 Science Block 1st Floor  
 Prep room







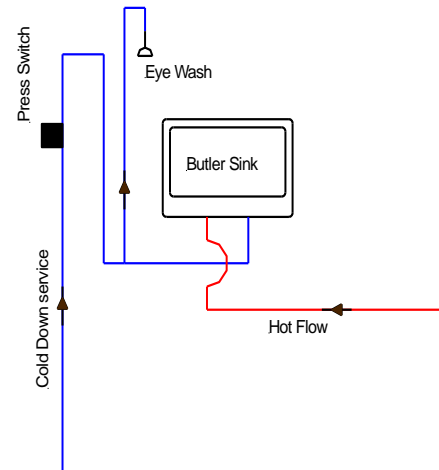
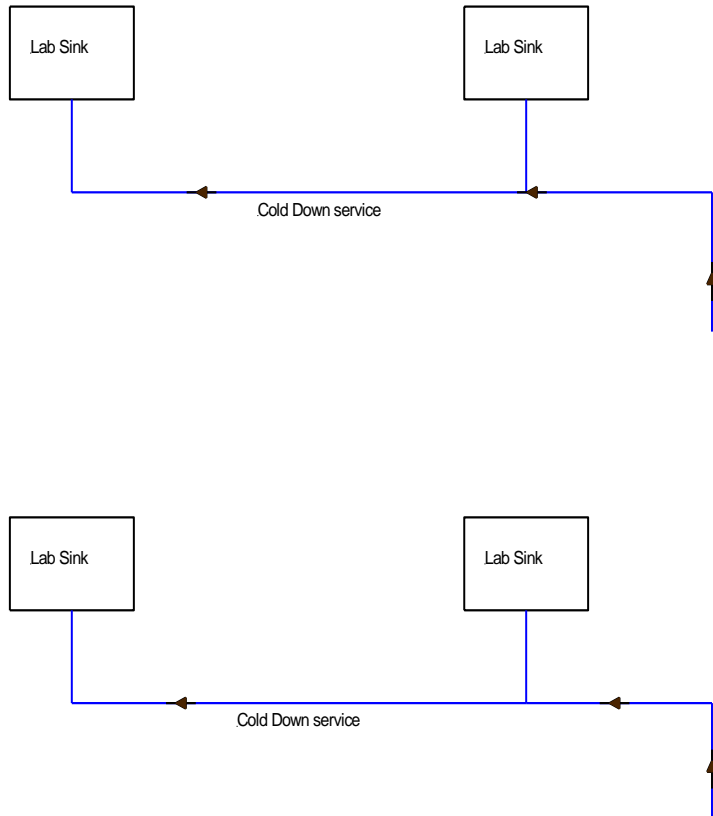





Date 31st May 2018

Drawing No.7





### KEY

-  Ball A Fix Valve
- bf**  Check Valve
-  Laboratory Tap
-  Blender Valve
-  Pump
-  Isolating Valve
-  Safety Valve
-  Drinking Fountain
-  Shower
-  Mains Water Service
-  Cold Water Down Service
-  Hot Flow/Return

### Note

This drawing was prepared for the Legionellosis Risk Assessment Report and not intended as a scaled system drawing. Drawings are based on a visual inspection carried out during the Risk Assessment and information given at the time of the survey. Some areas of pipe work may not have been visible during the survey therefore some assumptions may have been made in order to create this drawing. This drawing is not to scale.

**Freeston Water Treatment Unit 1**  
**Lulworth Business Centre**  
**Calmore Industrial Estate**  
**Totton Southampton**  
**SO40 3WW**  
**Tel 02380669713**

Site Ref  
 Sholing Technology College  
 Science Block 1st Floor  
 Laboratory 2

Date 31st May 2018

Drawing No.8

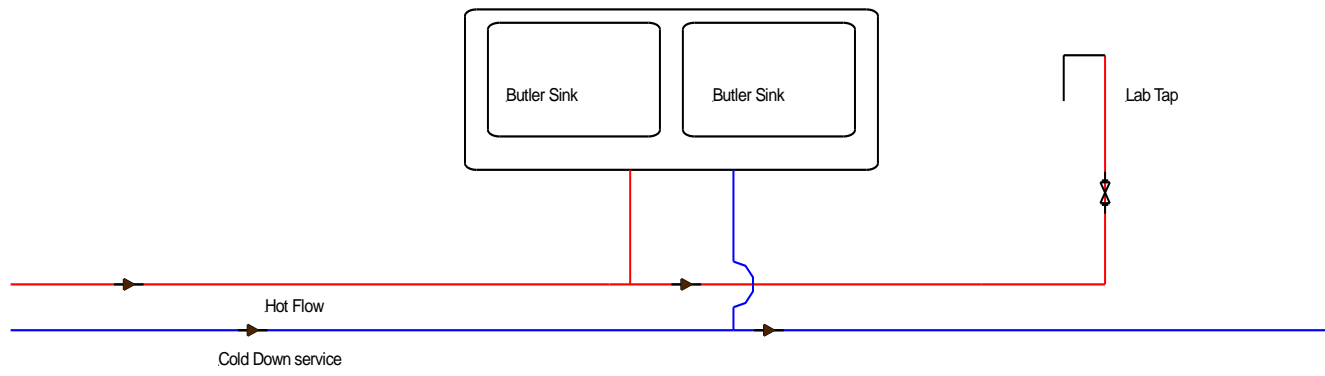

**KEY**

-  Ball A Fix Valve
-  Check Valve
-  Laboratory Tap
-  Blender Valve
-  Pump
-  Isolating Valve
-  Safety Valve
-  Drinking Fountain
-  Shower
-  Mains Water Service
-  Cold Water Down Service
-  Hot Flow/Return

**Note**  
 This drawing was prepared for the Legionellosis Risk Assessment Report and not intended as a scaled system drawing.  
 Drawings are based on a visual inspection carried out during the Risk Assessment and information given at the time of the survey.  
 Some areas of pipe work may not have been visible during the survey therefore some assumptions may have been made in order to create this drawing.  
 This drawing is not to scale.

*Freeston Water Treatment  
 Unit 1  
 Lulworth Business Centre  
 Calmore Industrial Estate  
 Totton Southampton  
 SO40 3WW  
 Tel 02380669713*







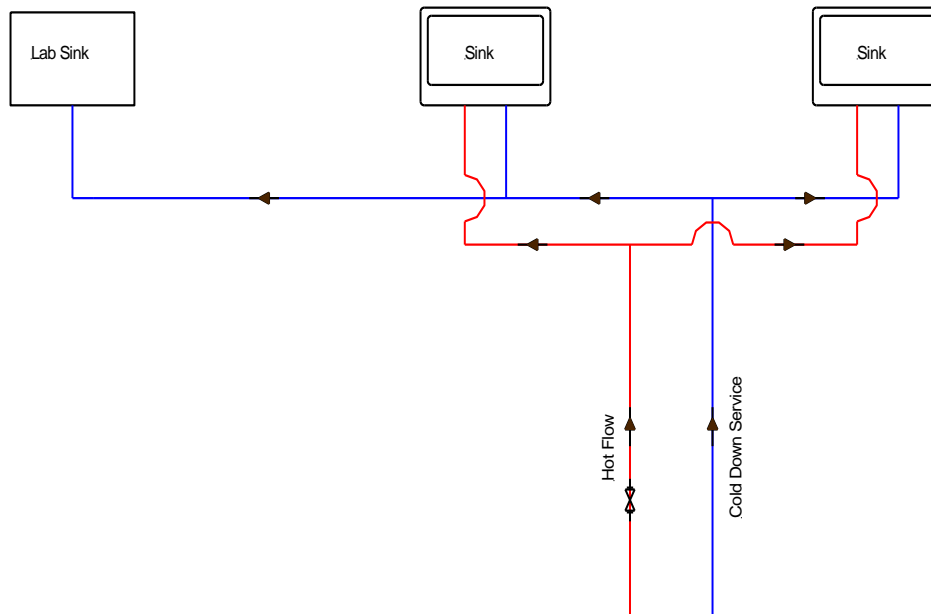





Site Ref  
 Sholing Technical College  
 Science Block 1st Floor  
 Prep room

Date 31st May 2018

Drawing No.9



### KEY

-  Ball A Fix Valve
- bf**
-  Check Valve
-  Laboratory Tap
-  Blender Valve
-  Pump
-  Isolating Valve
-  Safety Valve
-  Drinking Fountain
-  Shower
-  Mains Water Service
-  Cold Water Down Service
-  Hot Flow/Return

### Note

This drawing was prepared for the Legionellosis Risk Assessment Report and not intended as a scaled system drawing. Drawings are based on a visual inspection carried out during the Risk Assessment and information given at the time of the survey. Some areas of pipe work may not have been visible during the survey therefore some assumptions may have been made in order to create this drawing. This drawing is not to scale.

*Freeston Water Treatment  
Unit 1  
Lulworth Business Centre  
Calmore Industrial Estate  
Totton Southampton  
SO40 3WW  
Tel 02380669713*

Site Ref  
Sholing Technology College  
Science Block 1st Floor  
Laboratory 3

Date 31st May 2018

Drawing No.10

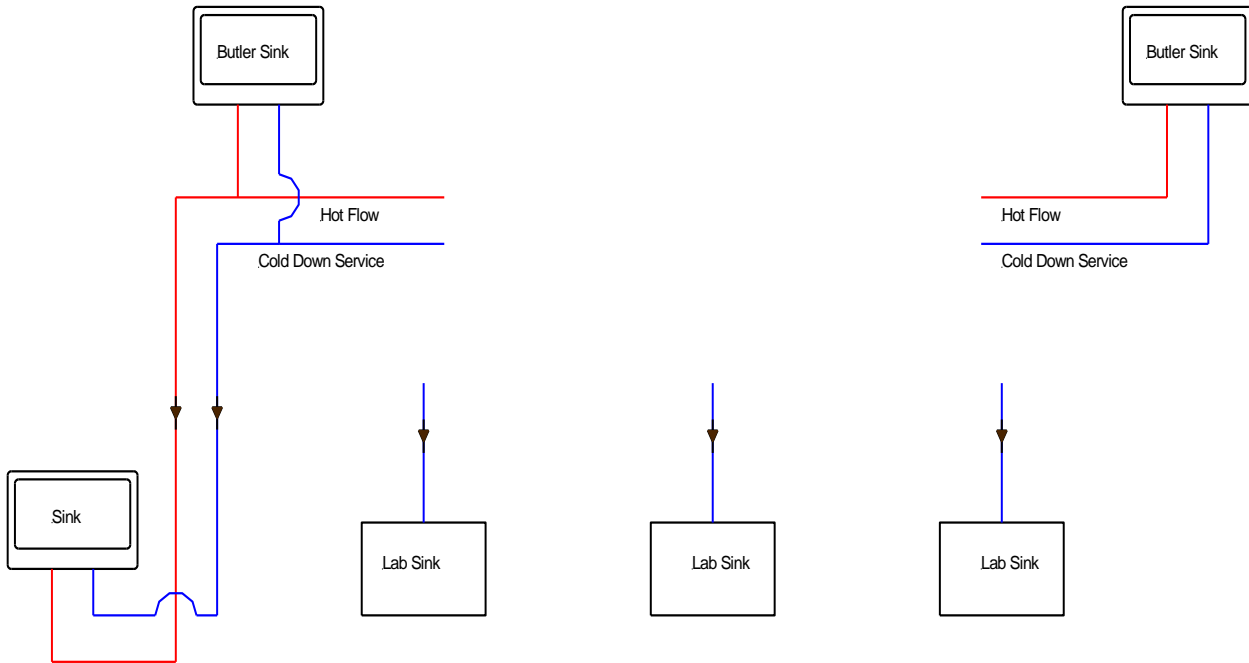

**KEY**

-  Ball A Fix Valve
-  bf
-  Check Valve
-  Laboratory Tap
-  Blender Valve
-  Pump
-  Isolating Valve
-  Safety Valve
-  Drinking Fountain
-  Shower
-  Mains Water Service
-  Cold Water Down Service
-  Hot Flow/Return

**Note**

This drawing was prepared for the Legionellosis Risk Assessment Report and not intended as a scaled system drawing.  
 Drawings are based on a visual inspection carried out during the Risk Assessment and information given at the time of the survey.  
 Some areas of pipe work may not have been visible during the survey therefore some assumptions may have been made in order to create this drawing.  
 This drawing is not to scale.

*Freeston Water Treatment  
 Unit 1  
 Lulworth Business Centre  
 Calmore Industrial Estate  
 Totton Southampton  
 SO40 3WW  
 Tel 02380669713*







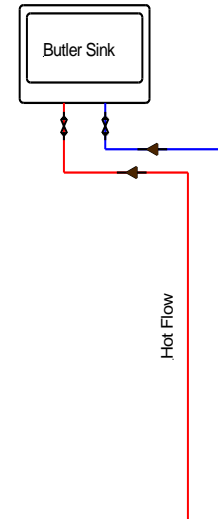
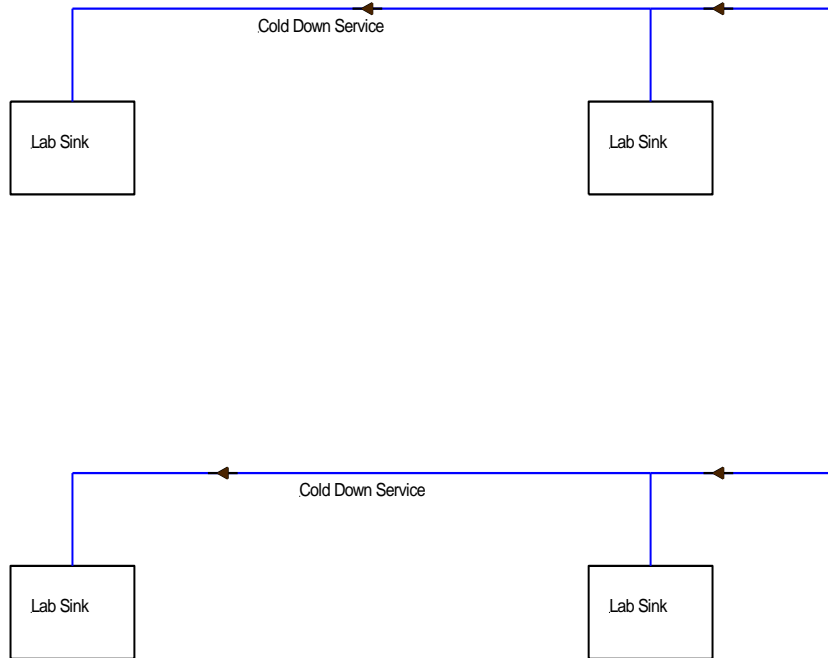





Site Ref  
 Sholing Technology College  
 Science Block 1st Floor  
 Laboratory 4

Date 31st May 2018

Drawing No.11



### KEY

-  Ball A Fix Valve
- bf**  Check Valve
-  Laboratory Tap
-  Blender Valve
-  Pump
-  Isolating Valve
-  Safety Valve
-  Drinking Fountain
-  Shower
-  Mains Water Service
-  Cold Water Down Service
-  Hot Flow/Return

### Note

This drawing was prepared for the Legionellosis Risk Assessment Report and not intended as a scaled system drawing. Drawings are based on a visual inspection carried out during the Risk Assessment and information given at the time of the survey. Some areas of pipe work may not have been visible during the survey therefore some assumptions may have been made in order to create this drawing. This drawing is not to scale.

**Freeston Water Treatment  
Unit 1  
Lulworth Business Centre  
Calmore Industrial Estate  
Totton Southampton  
SO40 3WW  
Tel 02380669713**







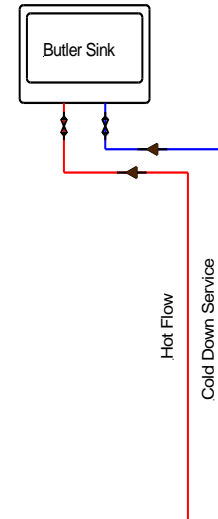
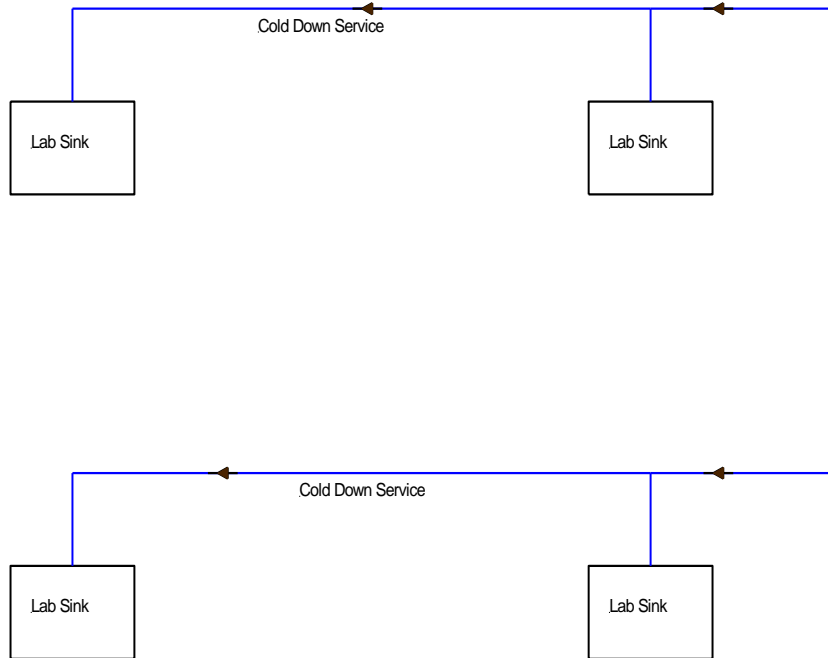





Site Ref  
Sholing Technology College  
Science Block 1st Floor  
Laboratory 5

Date 31st May 2018

Drawing No.12



### KEY

-  Ball A Fix Valve
-  bf
-  Check Valve
-  Laboratory Tap
-  Blender Valve
-  Pump
-  Isolating Valve
-  Safety Valve
-  Drinking Fountain
-  Shower
-  Mains Water Service
-  Cold Water Down Service
-  Hot Flow/Return

### Note

This drawing was prepared for the Legionellosis Risk Assessment Report and not intended as a scaled system drawing. Drawings are based on a visual inspection carried out during the Risk Assessment and information given at the time of the survey. Some areas of pipe work may not have been visible during the survey therefore some assumptions may have been made in order to create this drawing. This drawing is not to scale.

*Freeston Water Treatment  
Unit 1  
Lulworth Business Centre  
Calmore Industrial Estate  
Totton Southampton  
SO40 3WW  
Tel 02380669713*

Site Ref  
Sholing Technology College  
Science Block Ground Floor  
Laboratory 6

Date 31st May 2018

Drawing No.13

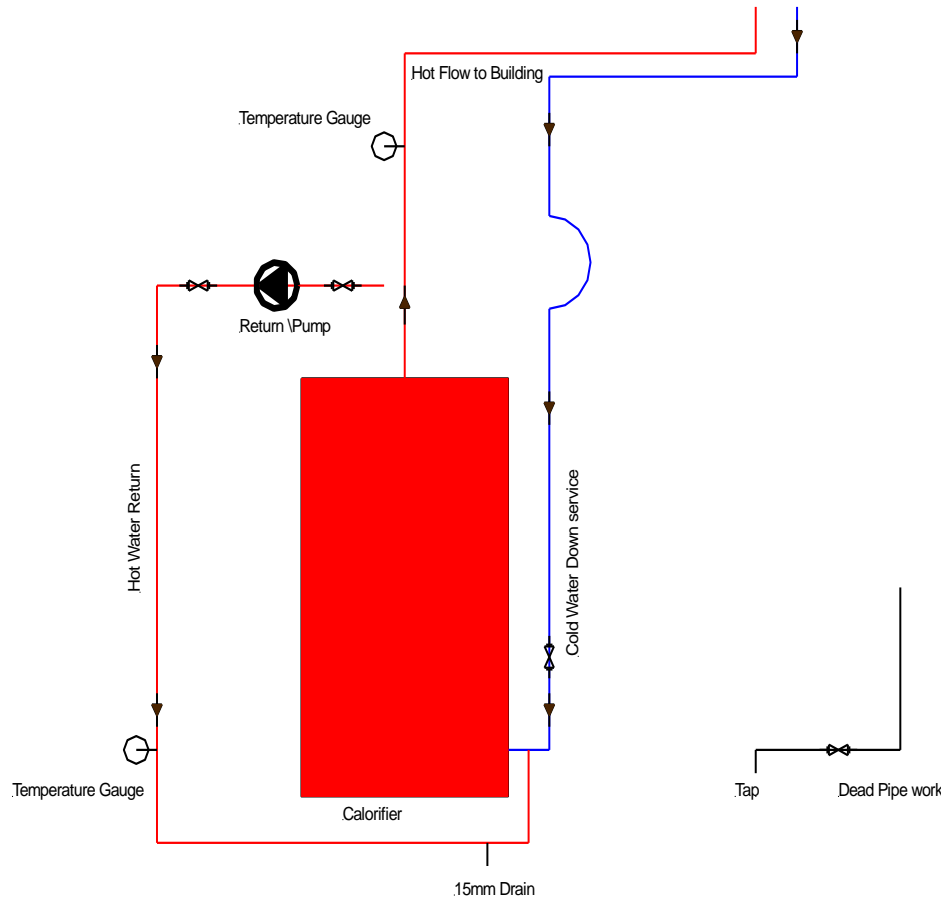

### KEY

-  Ball A Fix Valve
-  bf
-  Check Valve
-  Laboratory Tap
-  Blender Valve
-  Pump
-  Isolating Valve
-  Safety Valve
-  Drinking Fountain
-  Shower
-  Mains Water Service
-  Cold Water Down Service
-  Hot Flow/Return

### Note

This drawing was prepared for the Legionellosis Risk Assessment Report and not intended as a scaled system drawing.

Drawings are based on a visual inspection carried out during the Risk Assessment and information given at the time of the survey.

Some areas of pipe work may not have been visible during the survey therefore some assumptions may have been made in order to create this drawing.

This drawing is not to scale.

**Freeston Water Treatment Unit 1**  
**Lulworth Business Centre**  
**Calmore Industrial Estate**  
**Totton Southampton**  
**SO40 3WW**  
**Tel 02380669713**

Site Ref  
 Sholing Technology College  
 Science Block Plant Room  
 Calorifier

Date 31st May 2018

Drawing No.14

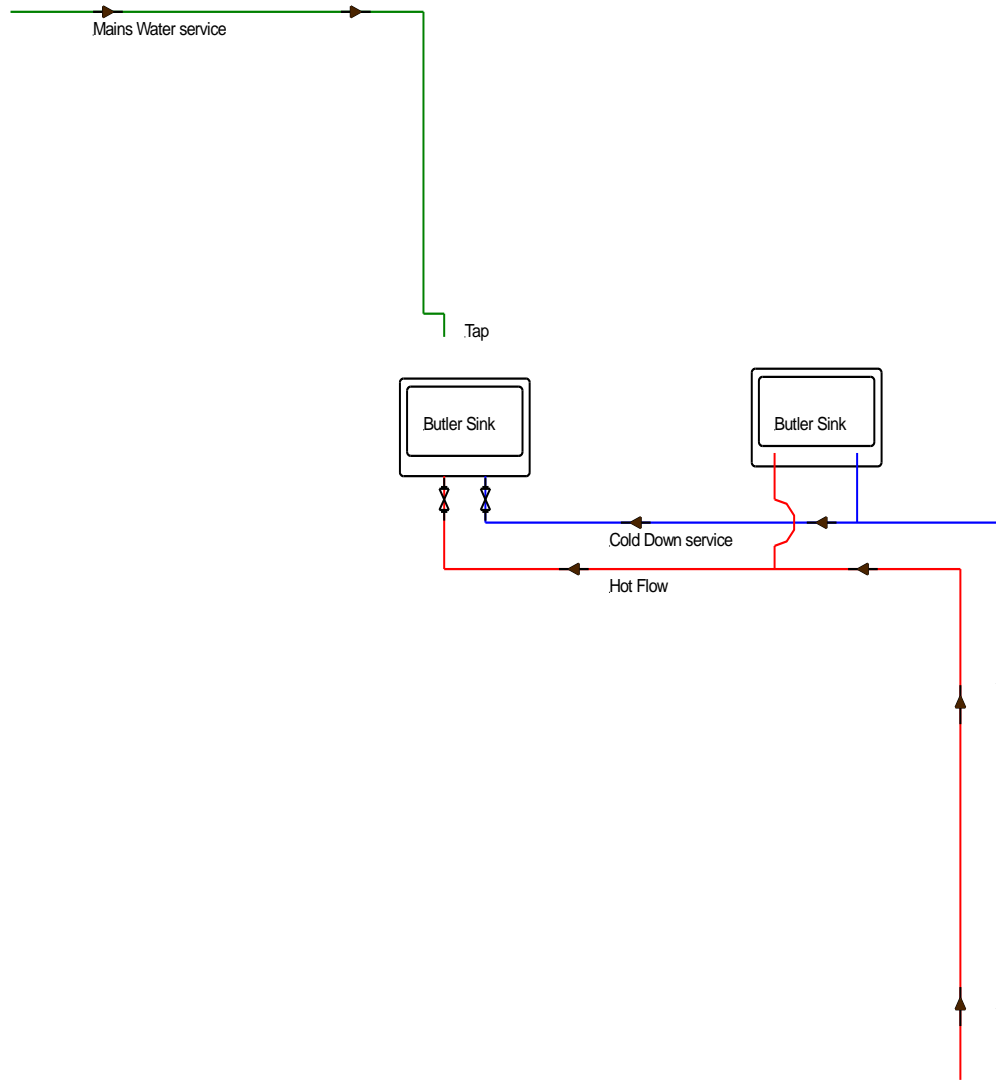

### KEY

-  Ball A Fix Valve
-  bf
-  Check Valve
-  Laboratory Tap
-  Blender Valve
-  Pump
-  Isolating Valve
-  Safety Valve
-  Drinking Fountain
-  Shower
-  Mains Water Service
-  Cold Water Down Service
-  Hot Flow/Return

### Note

This drawing was prepared for the Legionellosis Risk Assessment Report and not intended as a scaled system drawing. Drawings are based on a visual inspection carried out during the Risk Assessment and information given at the time of the survey. Some areas of pipe work may not have been visible during the survey therefore some assumptions may have been made in order to create this drawing. This drawing is not to scale.

**Freeston Water Treatment  
Unit 1  
Lulworth Business Centre  
Calmore Industrial Estate  
Totton Southampton  
SO40 3WW  
Tel 02380669713**

Site Ref  
Sholing Technical College  
Science Block Ground Floor  
Prep Room by Lab 6

Date 31st May 2018

Drawing No.15



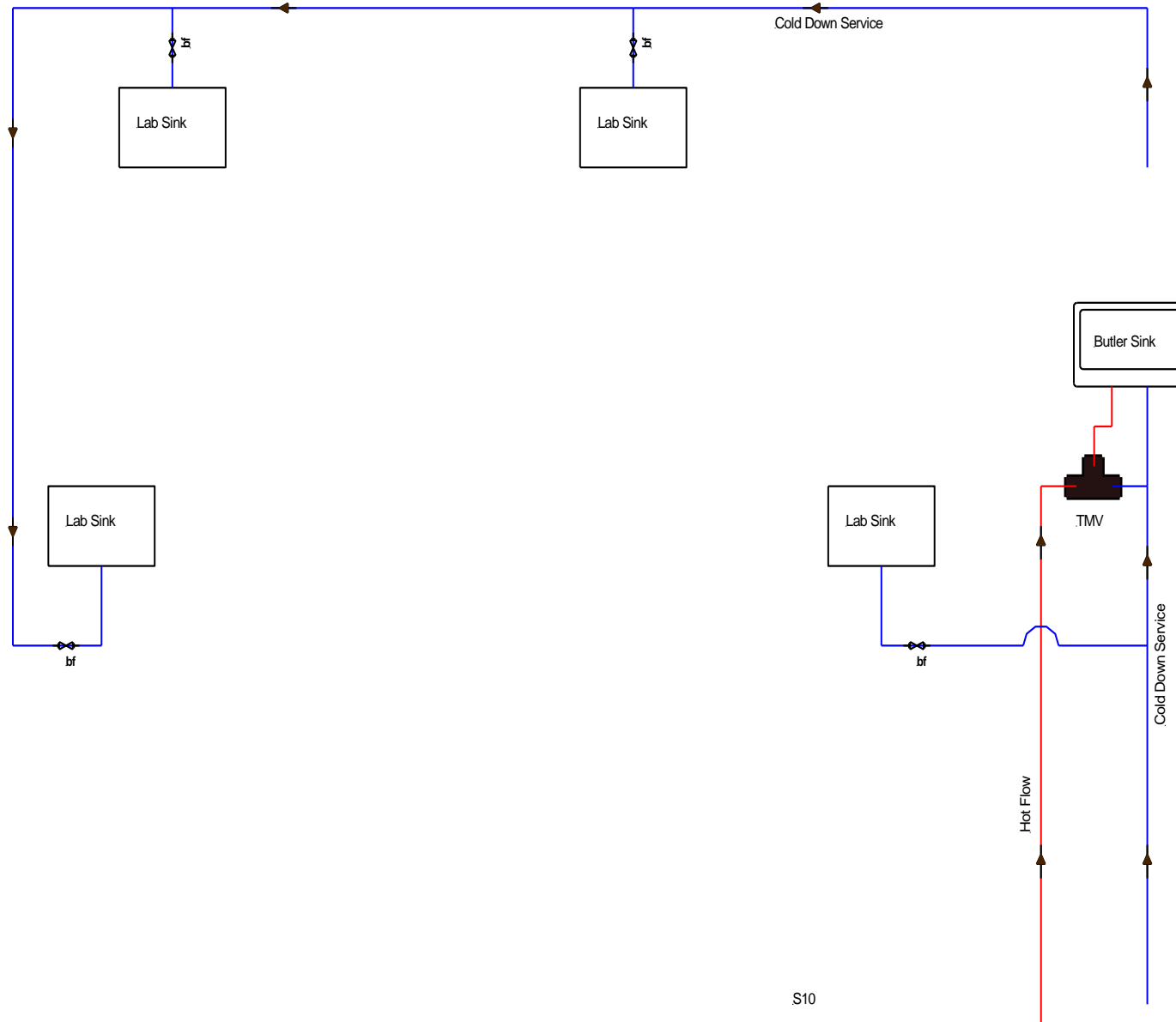

### KEY

-  Ball A Fix Valve
-  Check Valve
-  Laboratory Tap
-  Blender Valve
-  Pump
-  Isolating Valve
-  Safety Valve
-  Drinking Fountain
-  Shower
-  Mains Water Service
-  Cold Water Down Service
-  Hot Flow/Return

### Note

This drawing was prepared for the Legionellosis Risk Assessment Report and not intended as a scaled system drawing. Drawings are based on a visual inspection carried out during the Risk Assessment and information given at the time of the survey. Some areas of pipe work may not have been visible during the survey therefore some assumptions may have been made in order to create this drawing. This drawing is not to scale.

**Freeston Water Treatment  
Unit 1  
Lulworth Business Centre  
Calmore Industrial Estate  
Totton Southampton  
SO40 3WW  
Tel 02380669713**

Site Ref  
Sholing Technology College  
Science Block Ground Floor  
Laboratory S10

Date 31st May 2018

Drawing No.16

S10

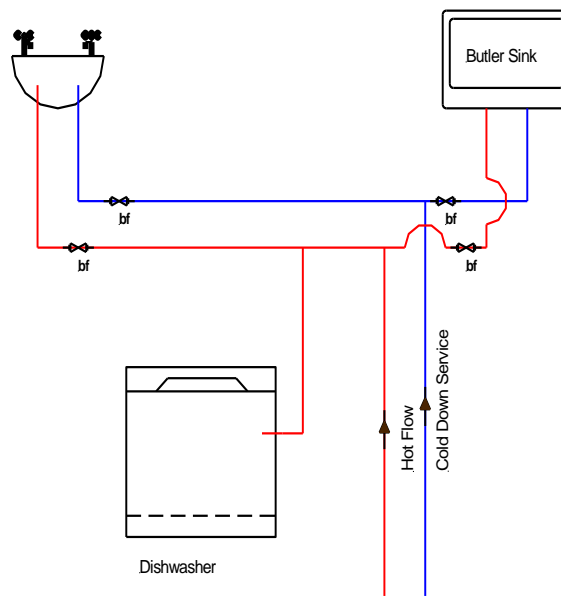

## KEY

-  Ball A Fix Valve
-  bf
-  Check Valve
-  Laboratory Tap
-  Blender Valve
-  Pump
-  Isolating Valve
-  Safety Valve
-  Drinking Fountain
-  Shower
-  Mains Water Service
-  Cold Water Down Service
-  Hot Flow/Return

## Note

This drawing was prepared for the Legionellosis Risk Assessment Report and not intended as a scaled system drawing. Drawings are based on a visual inspection carried out during the Risk Assessment and information given at the time of the survey. Some areas of pipe work may not have been visible during the survey therefore some assumptions may have been made in order to create this drawing. This drawing is not to scale.

*Freeston Water Treatment  
Unit 1  
Lulworth Business Centre  
Calmore Industrial Estate  
Totton Southampton  
SO40 3WW  
Tel 02380669713*

Site Ref  
Sholing Technology College  
Science Block Ground Floor  
Prep Room by S11

Date 31st May 2018

Drawing No.17

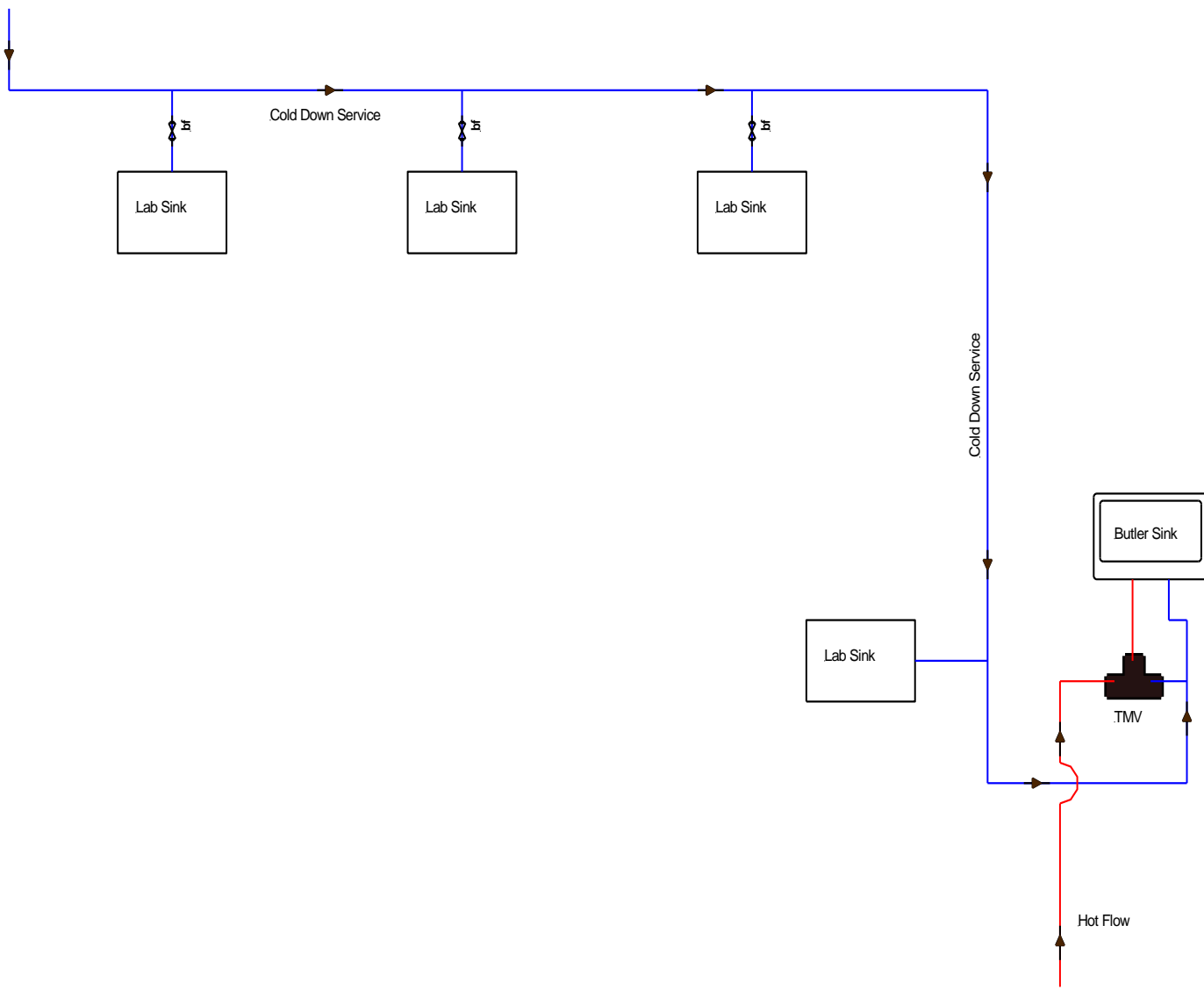

**KEY**

- Ball A Fix Valve
- bf
- Check Valve
- Laboratory Tap
- Blender Valve
- Pump
- Isolating Valve
- Safety Valve
- Drinking Fountain
- Shower
- Mains Water Service
- Cold Water Down Service
- Hot Flow/Return

**Note**

This drawing was prepared for the Legionellosis Risk Assessment Report and not intended as a scaled system drawing. Drawings are based on a visual inspection carried out during the Risk Assessment and information given at the time of the survey. Some areas of pipe work may not have been visible during the survey therefore some assumptions may have been made in order to create this drawing. This drawing is not to scale.

*Freeston Water Treatment Unit 1  
Lulworth Business Centre  
Calmore Industrial Estate  
Totton Southampton  
SO40 3WW  
Tel 02380669713*

Site Ref  
Sholing Technology College  
Science Block Ground Floor  
Laboratory S11

Date 31st May 2018

Drawing No.18

S11

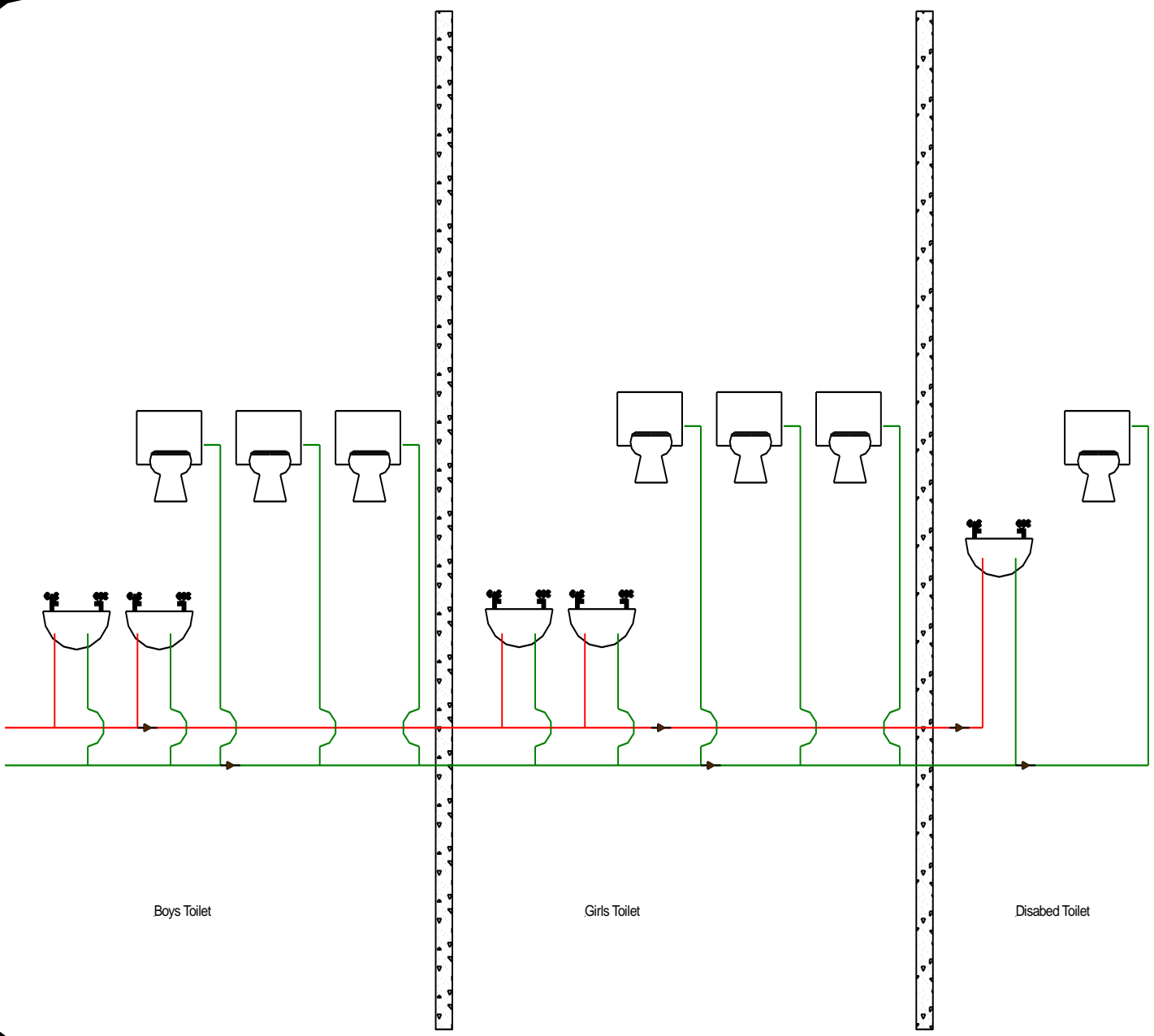

Boys Toilet

Girls Toilet

Disabled Toilet

**KEY**

-  Ball A Fix Valve
-  bf
-  Check Valve
-  Laboratory Tap
-  Blender Valve
-  Pump
-  Isolating Valve
-  Safety Valve
-  Drinking Fountain
-  Shower
-  Mains Water Service
-  Cold Water Down Service
-  Hot Flow/Return

**Note**

This drawing was prepared for the Legionellosis Risk Assessment Report and not intended as a scaled system drawing.  
 Drawings are based on a visual inspection carried out during the Risk Assessment and information given at the time of the survey.  
 Some areas of pipe work may not have been visible during the survey therefore some assumptions may have been made in order to create this drawing.  
 This drawing is not to scale.

*Freeston Water Treatment Unit 1  
 Lulworth Business Centre  
 Calmore Industrial Estate  
 Totton Southampton  
 SO40 3WW  
 Tel 02380669713*

Site Ref  
 Sholing Technology College  
 Science Block Ground Floor  
 Toilets

Date 31st May 2018

Drawing No.19

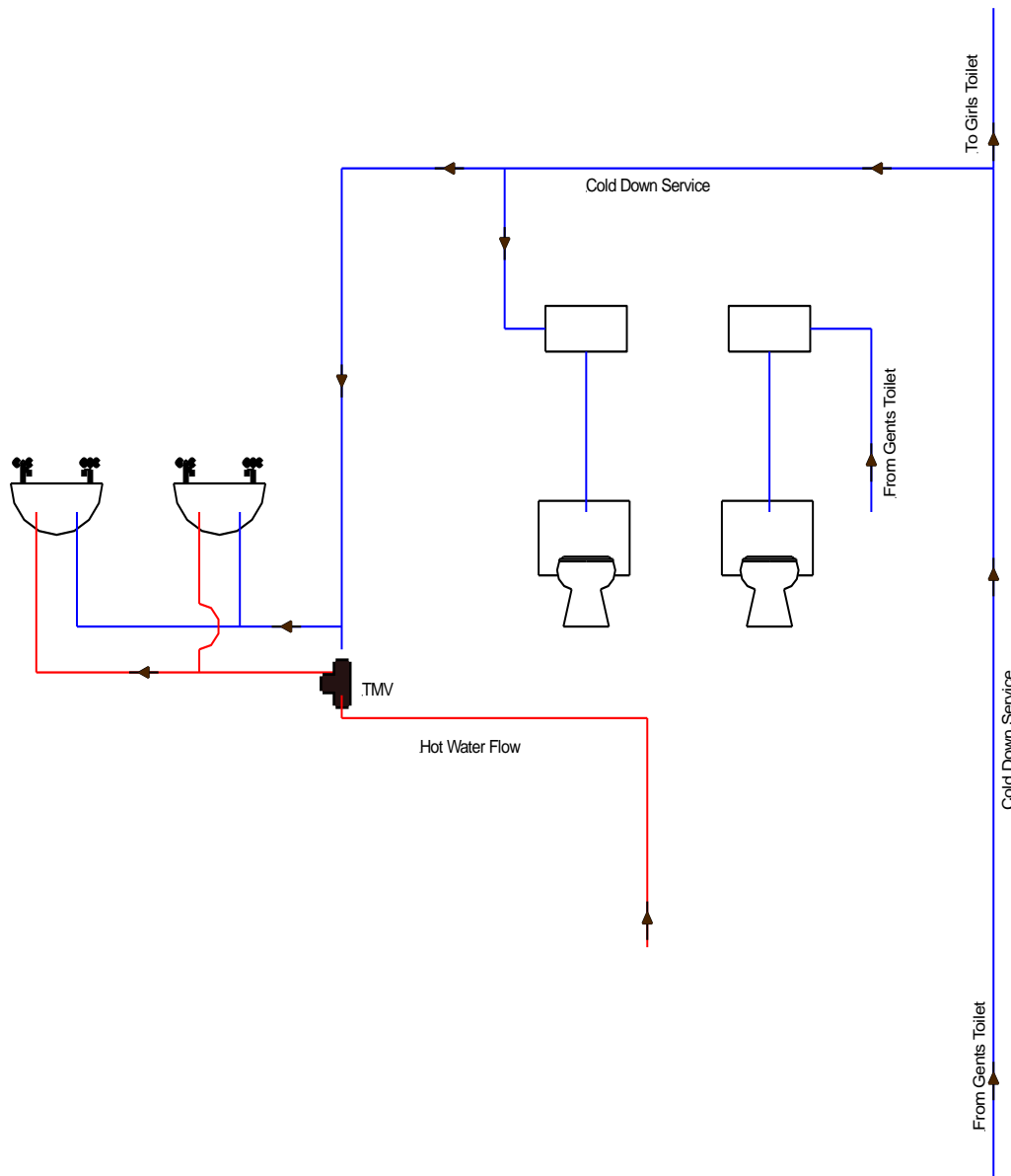

### KEY

-  Ball A Fix Valve
-  bf
-  Check Valve
-  Laboratory Tap
-  Blender Valve
-  Pump
-  Isolating Valve
-  Safety Valve
-  Drinking Fountain
-  Shower
-  Mains Water Service
-  Cold Water Down Service
-  Hot Flow/Return

### Note

This drawing was prepared for the Legionellosis Risk Assessment Report and not intended as a scaled system drawing.

Drawings are based on a visual inspection carried out during the Risk Assessment and information given at the time of the survey.

Some areas of pipe work may not have been visible during the survey therefore some assumptions may have been made in order to create this drawing.

This drawing is not to scale.

**Freeston Water Treatment  
Unit 1  
Lulworth Business Centre  
Calmore Industrial Estate  
Totton Southampton  
SO40 3WW  
Tel 02380669713**

Site Ref  
Sholing Technology College  
Science Block Ground Floor  
Ladies Staff Toilet

Date 31st May 2018

Drawing No.20

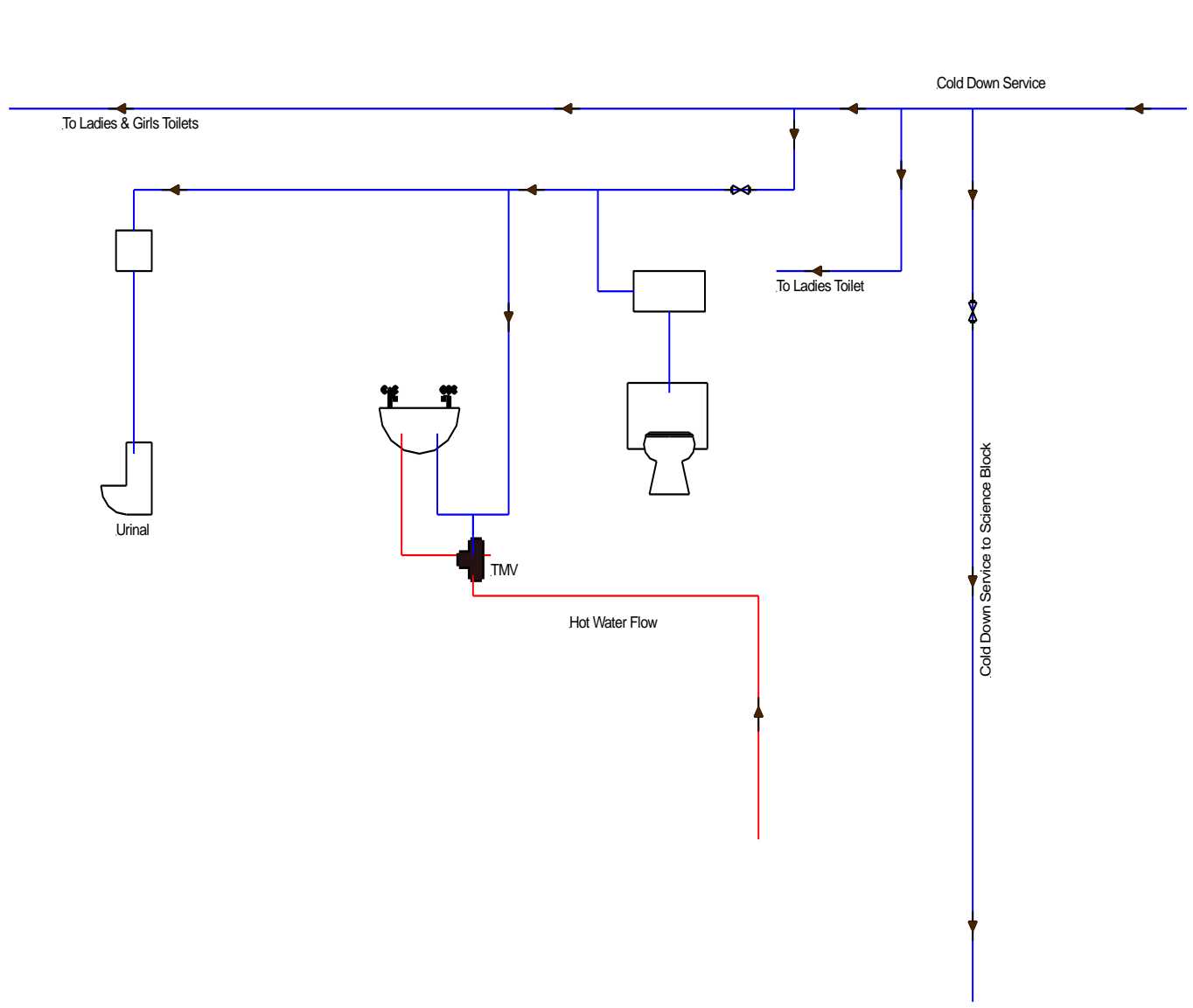

**KEY**

-  Ball A Fix Valve
-  Check Valve
-  Laboratory Tap
-  Blender Valve
-  Pump
-  Isolating Valve
-  Safety Valve
-  Drinking Fountain
-  Shower
-  Mains Water Service
-  Cold Water Down Service
-  Hot Flow/Return

**Note**

This drawing was prepared for the Legionellosis Risk Assessment Report and not intended as a scaled system drawing. Drawings are based on a visual inspection carried out during the Risk Assessment and information given at the time of the survey. Some areas of pipe work may not have been visible during the survey therefore some assumptions may have been made in order to create this drawing. This drawing is not to scale.

*Freeston Water Treatment Unit 1  
Lulworth Business Centre  
Calmore Industrial Estate  
Totton Southampton  
SO40 3WW  
Tel 02380669713*

Site Ref  
Sholing Technology College  
Science Block Ground Floor  
Mens Toilet

Date 31st May 2018

Drawing No.21

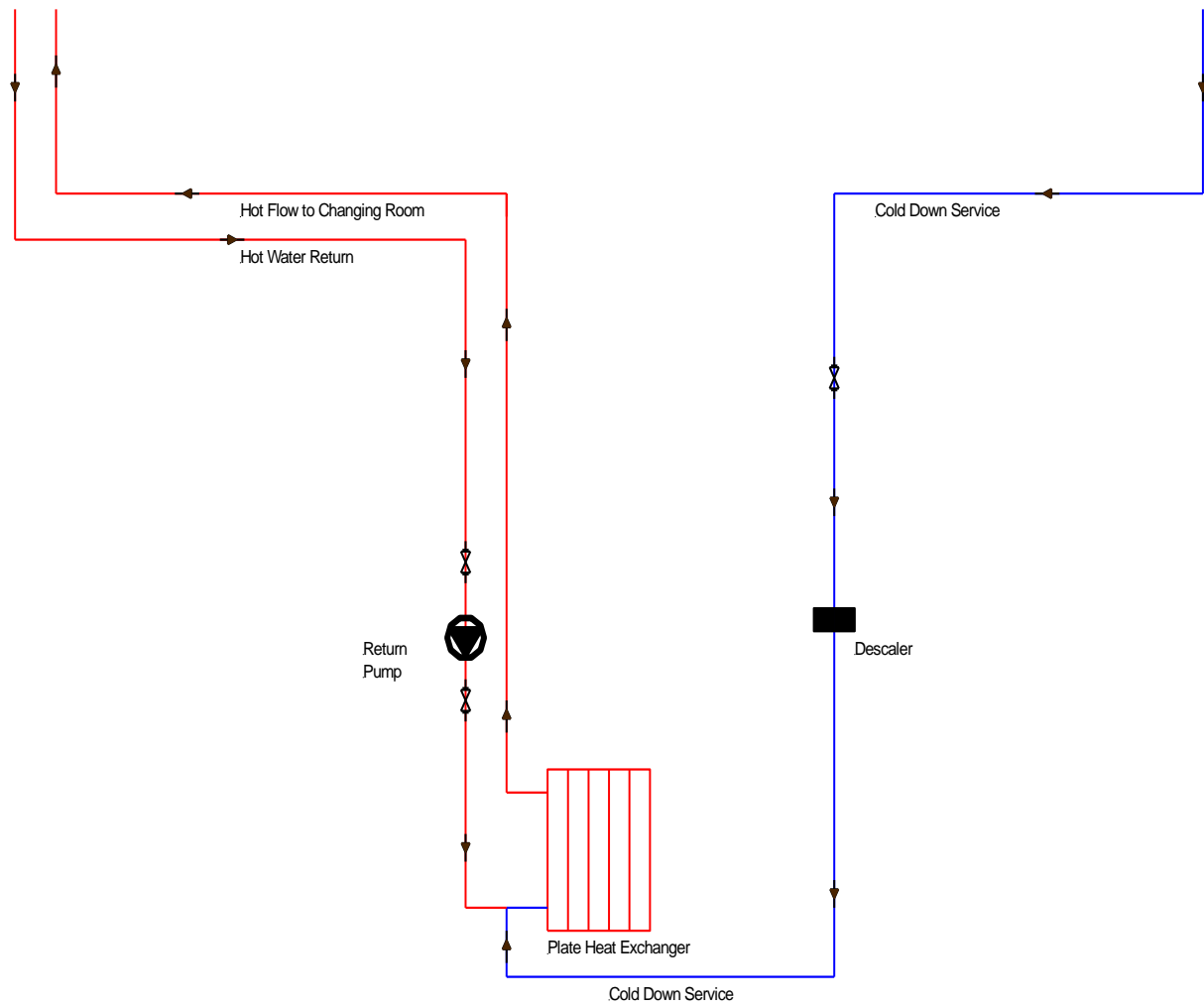

**KEY**

-  Ball A Fix Valve
-  bf
-  Check Valve
-  Laboratory Tap
-  Blender Valve
-  Pump
-  Isolating Valve
-  Safety Valve
-  Drinking Fountain
-  Shower
-  Mains Water Service
-  Cold Water Down Service
-  Hot Flow/Return

**Note**

This drawing was prepared for the Legionellosis Risk Assessment Report and not intended as a scaled system drawing. Drawings are based on a visual inspection carried out during the Risk Assessment and information given at the time of the survey. Some areas of pipe work may not have been visible during the survey therefore some assumptions may have been made in order to create this drawing. This drawing is not to scale.

*Freeston Water Treatment  
Unit 1  
Lulworth Business Centre  
Calmore Industrial Estate  
Totton Southampton  
SO40 3WW  
Tel 02380669713*

Site Ref  
Sholing Technology College  
Gym  
Plate Heat Exchanger

Date 31st May 2018

Drawing No.22

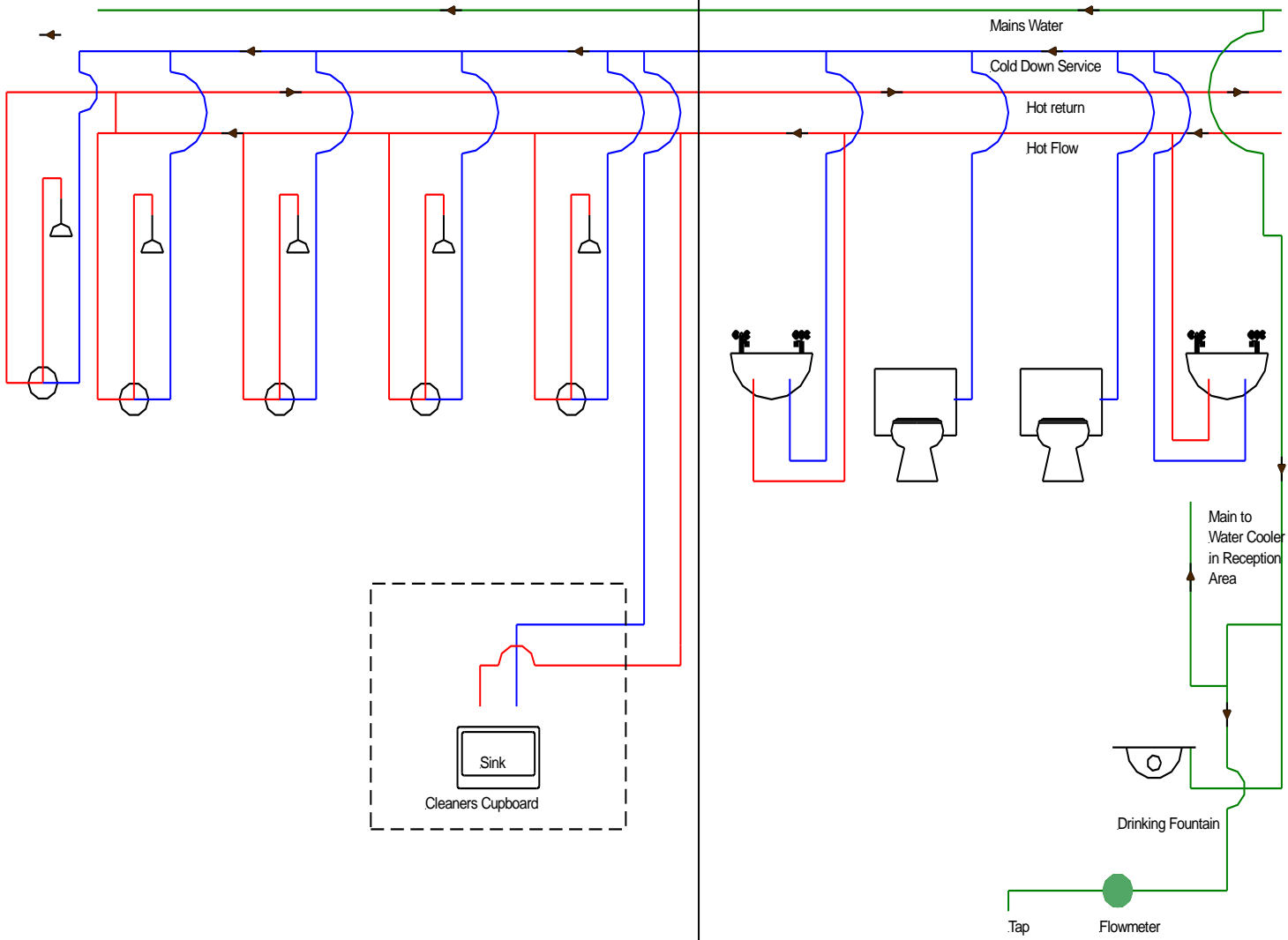

**KEY**

- Ball A Fix Valve
- bf
- Check Valve
- Laboratory Tap
- Blender Valve
- Pump
- Isolating Valve
- Safety Valve
- Drinking Fountain
- Shower
- Mains Water Service
- Cold Water Down Service
- Hot Flow/Return

**Note**

This drawing was prepared for the Legionellosis Risk Assessment Report and not intended as a scaled system drawing. Drawings are based on a visual inspection carried out during the Risk Assessment and information given at the time of the survey. Some areas of pipe work may not have been visible during the survey therefore some assumptions may have been made in order to create this drawing. This drawing is not to scale.

*Freeston Water Treatment Unit 1  
Lulworth Business Centre  
Calmore Industrial Estate  
Totton Southampton  
SO40 3WW  
Tel 02380669713*

Site Ref  
Sholing Technology College  
Gym Changing Room  
Shower Room & Toilet



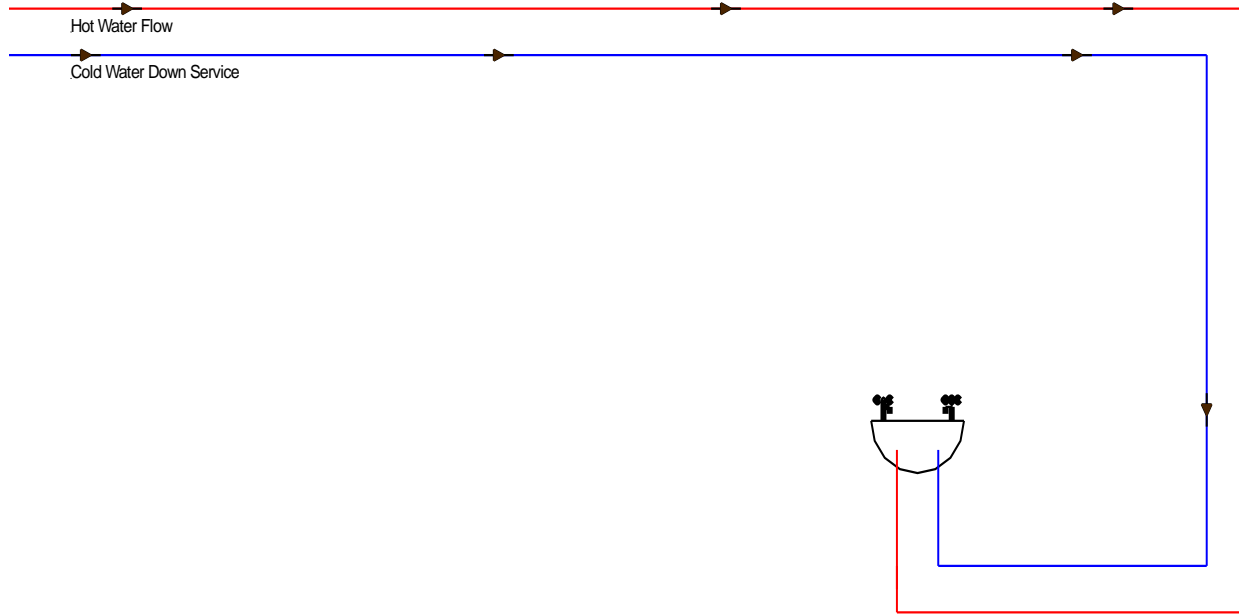

Date 31st May 2018

Drawing No.23





### KEY

-  Ball A Fix Valve
- bf**  Check Valve
-  Laboratory Tap
-  Blender Valve
-  Pump
-  Isolating Valve
-  Safety Valve
-  Drinking Fountain
-  Shower
-  Mains Water Service
-  Cold Water Down Service
-  Hot Flow/Return

### Note

This drawing was prepared for the Legionellosis Risk Assessment Report and not intended as a scaled system drawing.

Drawings are based on a visual inspection carried out during the Risk Assessment and information given at the time of the survey.

Some areas of pipe work may not have been visible during the survey therefore some assumptions may have been made in order to create this drawing.

This drawing is not to scale.

*Freeston Water Treatment  
Unit 1  
Lulworth Business Centre  
Calmore Industrial Estate  
Totton Southampton  
SO40 3WW  
Tel 02380669713*

Site Ref  
Sholing Technology College  
Gym P.E Office

Date 31st May 2018

Drawing No.24

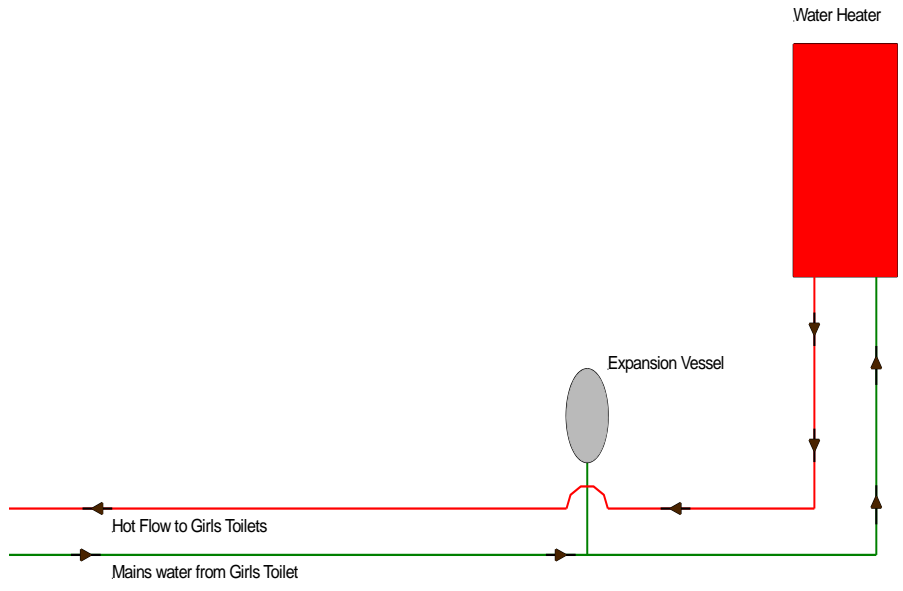

**KEY**

-  Ball A Fix Valve
- bf**
-  Check Valve
-  Laboratory Tap
-  Blender Valve
-  Pump
-  Isolating Valve
-  Safety Valve
-  Drinking Fountain
-  Shower
-  Mains Water Service
-  Cold Water Down Service
-  Hot Flow/Return

**Note**

This drawing was prepared for the Legionellosis Risk Assessment Report and not intended as a scaled system drawing.  
 Drawings are based on a visual inspection carried out during the Risk Assessment and information given at the time of the survey.  
 Some areas of pipe work may not have been visible during the survey therefore some assumptions may have been made in order to create this drawing.  
 This drawing is not to scale.

*Freeston Water Treatment  
 Unit 1  
 Lulworth Business Centre  
 Calmore Industrial Estate  
 Totton Southampton  
 SO40 3WW  
 Tel 02380669713*

Site Ref  
 Sholing Technology College  
 Humanities Block  
 1st Floor Toilet Water Heater

Date 31st May 2018

Drawing No.25

HE14

### KEY

-  Ball A Fix Valve
-  bf
-  Check Valve
-  Laboratory Tap
-  Blender Valve
-  Pump
-  Isolating Valve
-  Safety Valve
-  Drinking Fountain
-  Shower
-  Mains Water Service
-  Cold Water Down Service
-  Hot Flow/Return

### Note

This drawing was prepared for the Legionellosis Risk Assessment Report and not intended as a scaled system drawing.  
 Drawings are based on a visual inspection carried out during the Risk Assessment and information given at the time of the survey.  
 Some areas of pipe work may not have been visible during the survey therefore some assumptions may have been made in order to create this drawing.  
 This drawing is not to scale.

*Freeston Water Treatment Unit 1  
 Lulworth Business Centre  
 Calmore Industrial Estate  
 Totton Southampton  
 SO40 3WW  
 Tel 02380669713*

Site Ref  
 Sholing Technology College  
 Humanities Block 1st Floor  
 Girls Toilet

Date 31st May 2018

Drawing No.26

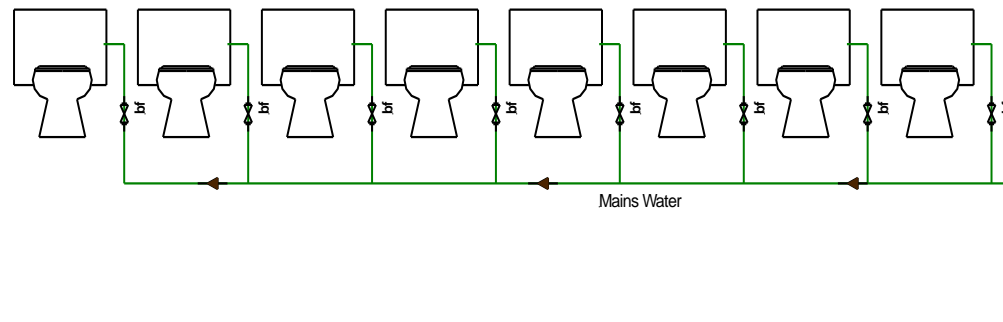
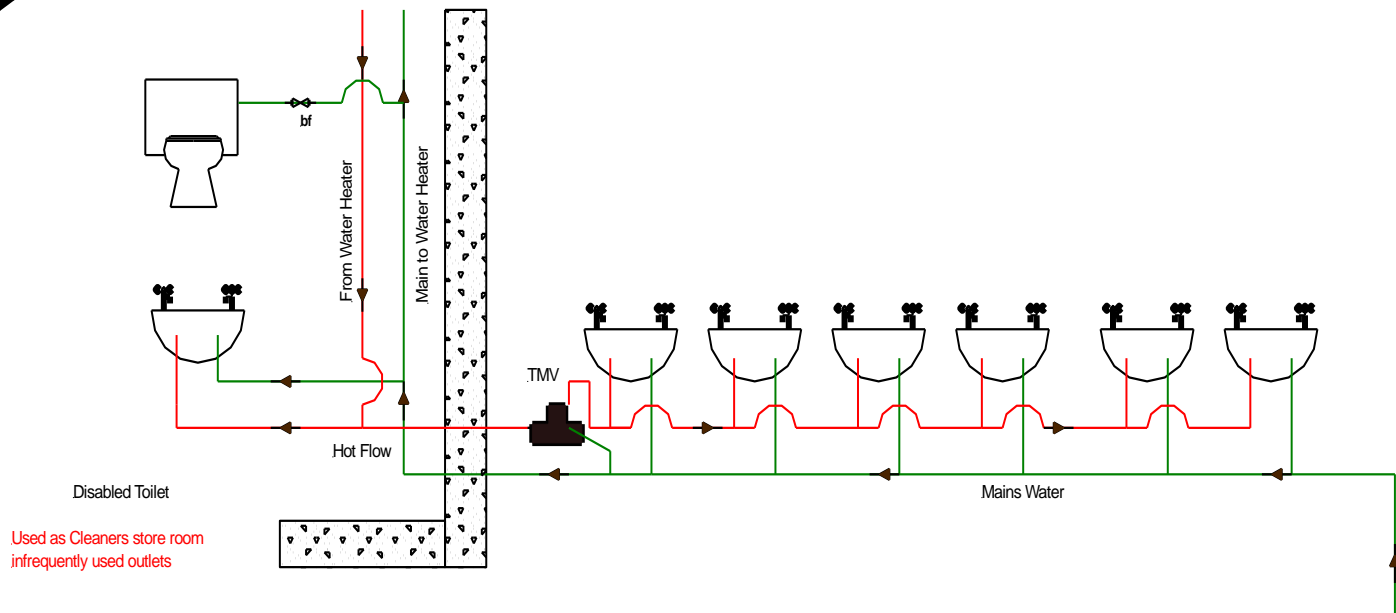

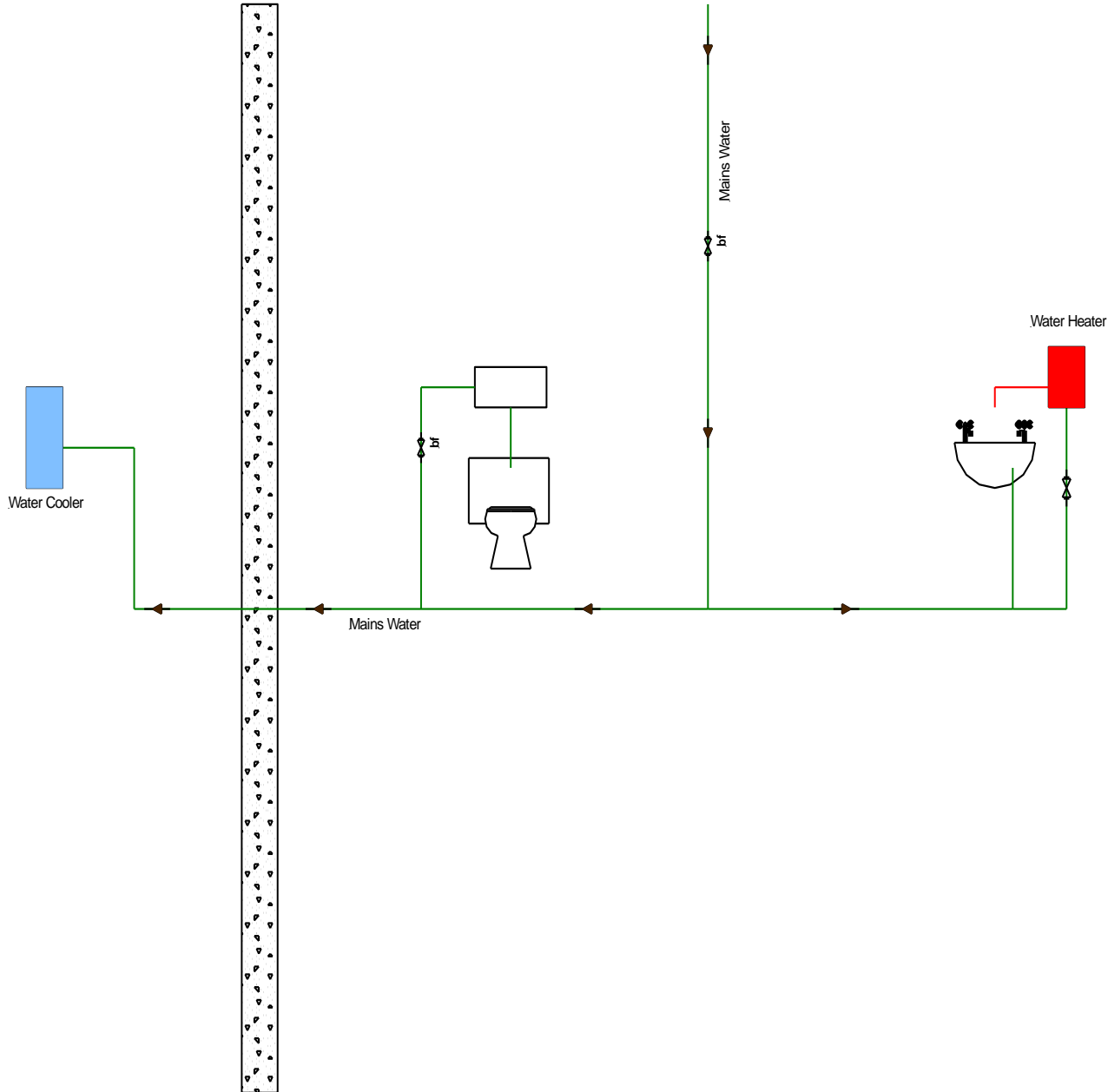

### KEY

-  Ball A Fix Valve
- bf**  Check Valve
-  Laboratory Tap
-  Blender Valve
-  Pump
-  Isolating Valve
-  Safety Valve
-  Drinking Fountain
-  Shower
-  Mains Water Service
-  Cold Water Down Service
-  Hot Flow/Return

### Note

This drawing was prepared for the Legionellosis Risk Assessment Report and not intended as a scaled system drawing. Drawings are based on a visual inspection carried out during the Risk Assessment and information given at the time of the survey. Some areas of pipe work may not have been visible during the survey therefore some assumptions may have been made in order to create this drawing. This drawing is not to scale.

*Freeston Water Treatment  
Unit 1  
Lulworth Business Centre  
Calmore Industrial Estate  
Totton Southampton  
SO40 3WW  
Tel 02380669713*

Site Ref  
Sholing Technology College  
Humanities Block Ground Floor  
Disabled Toilet

Date 31st May 2018

Drawing No.27

Toilets have been shut down for long period; only used for summer months.  
Ensure all water pipe work is drained including water heater or flush weekly.

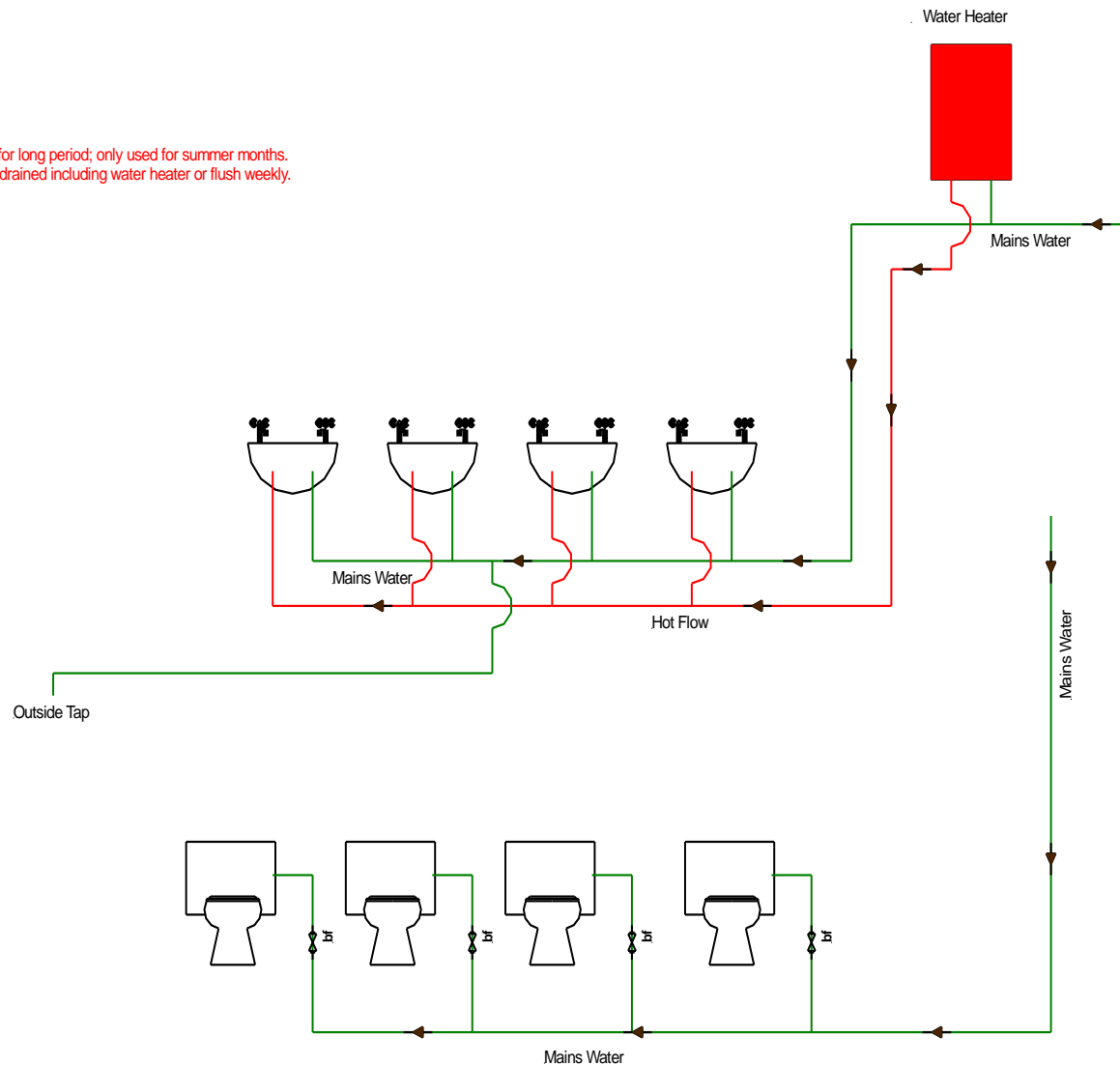

### KEY

-  Ball A Fix Valve
-  bf
-  Check Valve
-  Laboratory Tap
-  Blender Valve
-  Pump
-  Isolating Valve
-  Safety Valve
-  Drinking Fountain
-  Shower
-  Mains Water Service
-  Cold Water Down Service
-  Hot Flow/Return

### Note

This drawing was prepared for the Legionellosis Risk Assessment Report and not intended as a scaled system drawing.  
Drawings are based on a visual inspection carried out during the Risk Assessment and information given at the time of the survey.  
Some areas of pipe work may not have been visible during the survey therefore some assumptions may have been made in order to create this drawing.  
This drawing is not to scale.

**Freeston Water Treatment Unit 1**  
**Lulworth Business Centre**  
**Calmore Industrial Estate**  
**Totton Southampton**  
**SO40 3WW**  
**Tel 02380669713**

Site Ref  
Sholing Technology College  
Humanities Block Ground Floor  
Girls Toilet

Date 31st May 2018

Drawing No.28

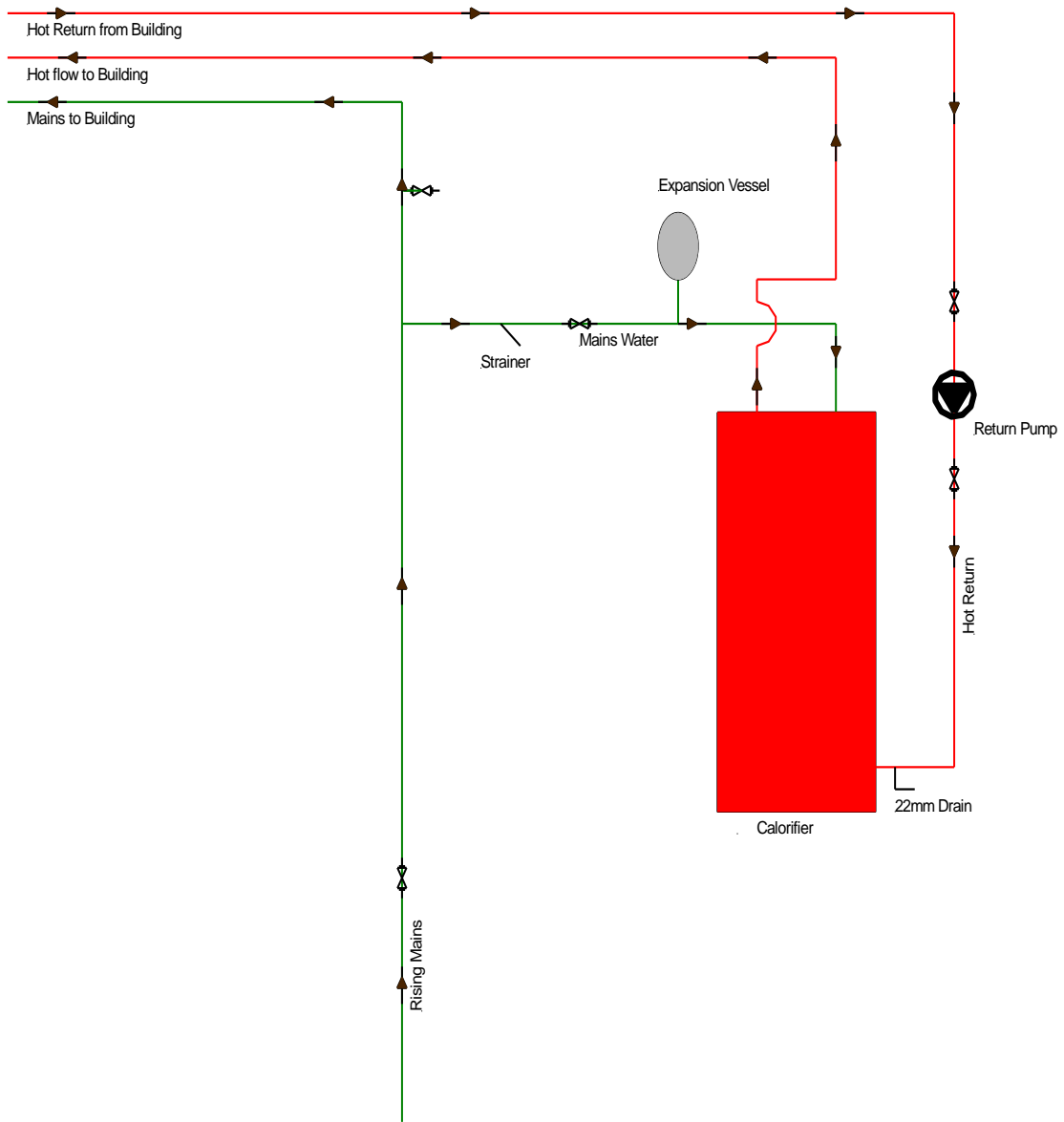

**KEY**

-  Ball A Fix Valve
-  bf
-  Check Valve
-  Laboratory Tap
-  Blender Valve
-  Pump
-  Isolating Valve
-  Safety Valve
-  Drinking Fountain
-  Shower
-  Mains Water Service
-  Cold Water Down Service
-  Hot Flow/Return

**Note**

This drawing was prepared for the Legionellosis Risk Assessment Report and not intended as a scaled system drawing.  
 Drawings are based on a visual inspection carried out during the Risk Assessment and information given at the time of the survey.  
 Some areas of pipe work may not have been visible during the survey therefore some assumptions may have been made in order to create this drawing.  
 This drawing is not to scale.

*Freeston Water Treatment  
 Unit 1  
 Lulworth Business Centre  
 Calmore Industrial Estate  
 Totton Southampton  
 SO40 3WW  
 Tel 02380669713*

Site Ref  
 Sholing Technology College  
 Art Block Plant Room  
 Calorifier

Date 31st May 2018

Drawing No.29

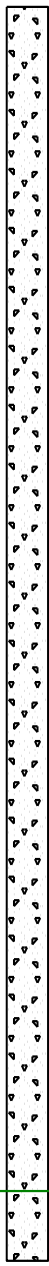
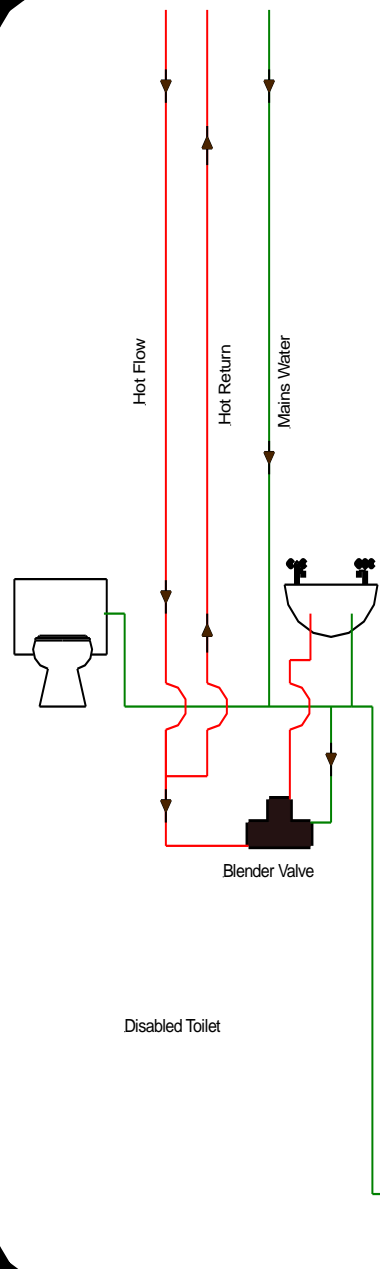

Water Cooler

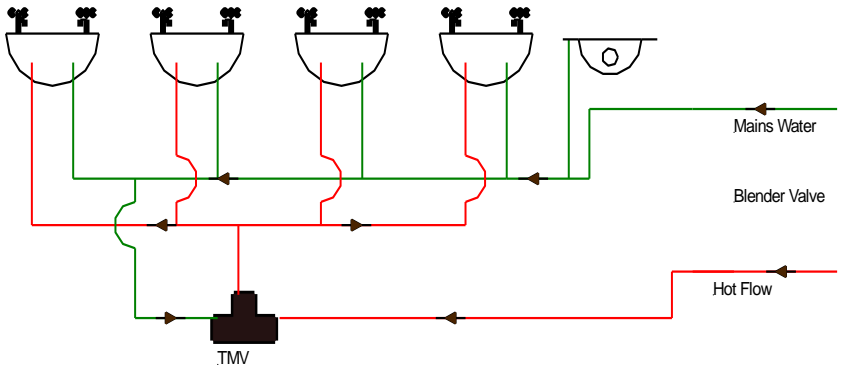
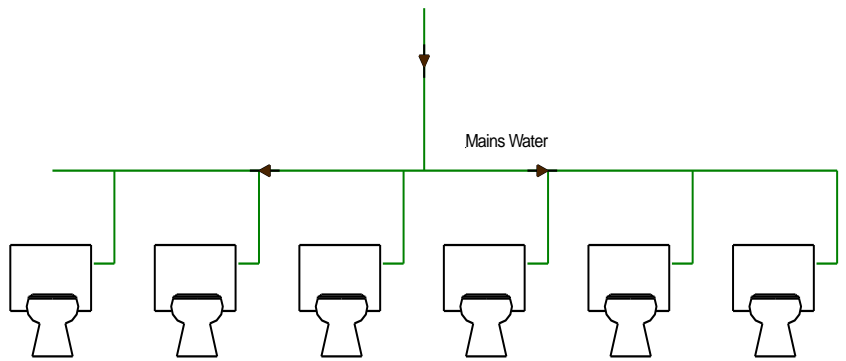

**KEY**

-  Ball A Fix Valve
-  bf
-  Check Valve
-  Laboratory Tap
-  Blender Valve
-  Pump
-  Isolating Valve
-  Safety Valve
-  Drinking Fountain
-  Shower
-  Mains Water Service
-  Cold Water Down Service
-  Hot Flow/Return

**Note**

This drawing was prepared for the Legionellosis Risk Assessment Report and not intended as a scaled system drawing. Drawings are based on a visual inspection carried out during the Risk Assessment and information given at the time of the survey. Some areas of pipe work may not have been visible during the survey therefore some assumptions may have been made in order to create this drawing. This drawing is not to scale.

*Freeston Water Treatment Unit 1  
Lulworth Business Centre  
Calmore Industrial Estate  
Totton Southampton  
SO40 3WW  
Tel 02380669713*

Site Ref  
Sholing Technology College  
Art Block Toilet Area

Date 31st May 2018

Drawing No.30

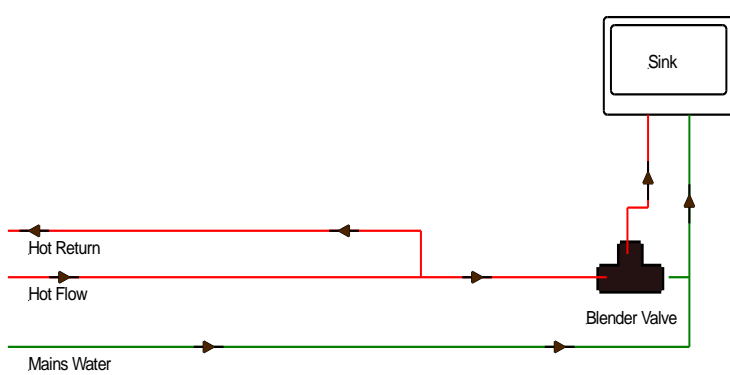
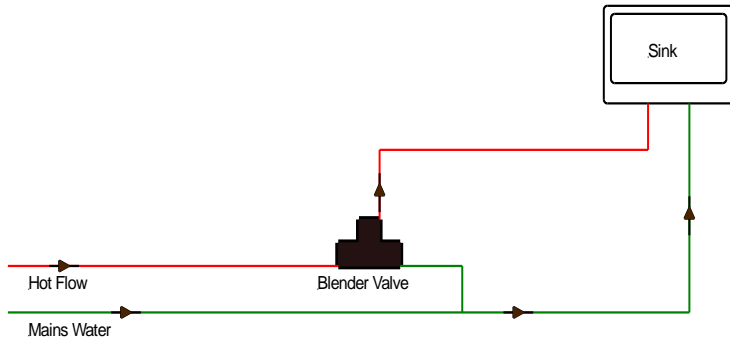

**KEY**

- Ball A Fix Valve
- bf
- Check Valve
- Laboratory Tap
- Blender Valve
- Pump
- Isolating Valve
- Safety Valve
- Drinking Fountain
- Shower
- Mains Water Service
- Cold Water Down Service
- Hot Flow/Return

**Note**

This drawing was prepared for the Legionellosis Risk Assessment Report and not intended as a scaled system drawing.  
 Drawings are based on a visual inspection carried out during the Risk Assessment and information given at the time of the survey.  
 Some areas of pipe work may not have been visible during the survey therefore some assumptions may have been made in order to create this drawing.  
 This drawing is not to scale.

*Freeston Water Treatment Unit 1  
 Lulworth Business Centre  
 Calmore Industrial Estate  
 Totton Southampton  
 SO40 3WW  
 Tel 02380669713*

Site Ref  
 Sholing Technology College  
 Art Block  
 Art Room 1 CA3

Date 31st May 2018

Drawing No.31

CA3



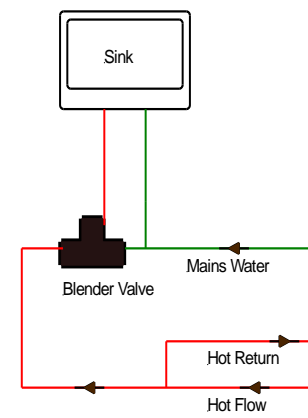
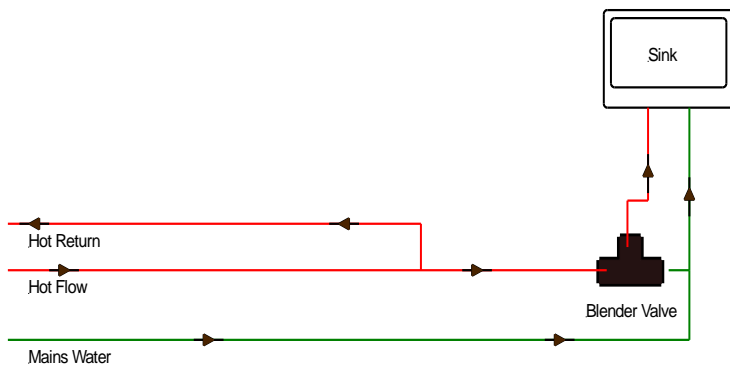
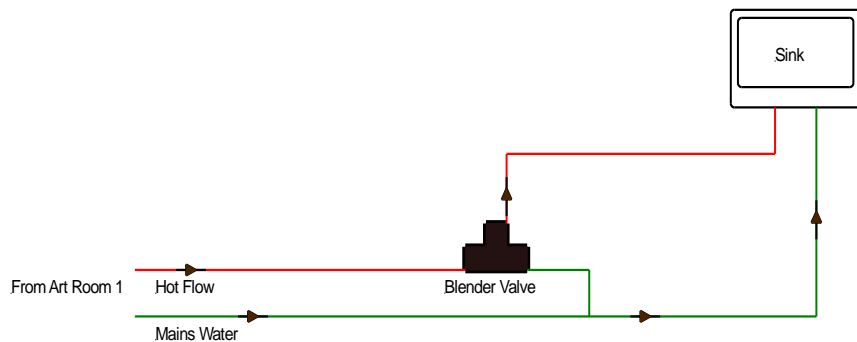

**KEY**

- Ball A Fix Valve
- bf
- Check Valve
- Laboratory Tap
- Blender Valve
- Pump
- Isolating Valve
- Safety Valve
- Drinking Fountain
- Shower
- Mains Water Service
- Cold Water Down Service
- Hot Flow/Return

**Note**

This drawing was prepared for the Legionellosis Risk Assessment Report and not intended as a scaled system drawing. Drawings are based on a visual inspection carried out during the Risk Assessment and information given at the time of the survey. Some areas of pipe work may not have been visible during the survey therefore some assumptions may have been made in order to create this drawing. This drawing is not to scale.

*Freeston Water Treatment Unit 1  
Lulworth Business Centre  
Calmore Industrial Estate  
Totton Southampton  
SO40 3WW  
Tel 02380669713*

Site Ref  
Sholing Technology College  
Art Block  
Pottery Room CA4







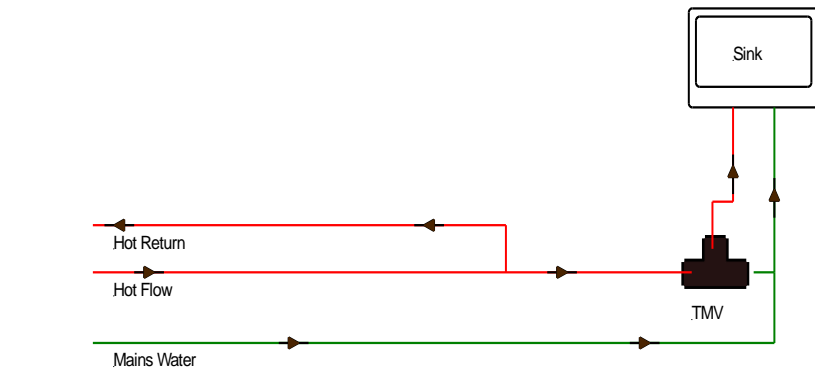
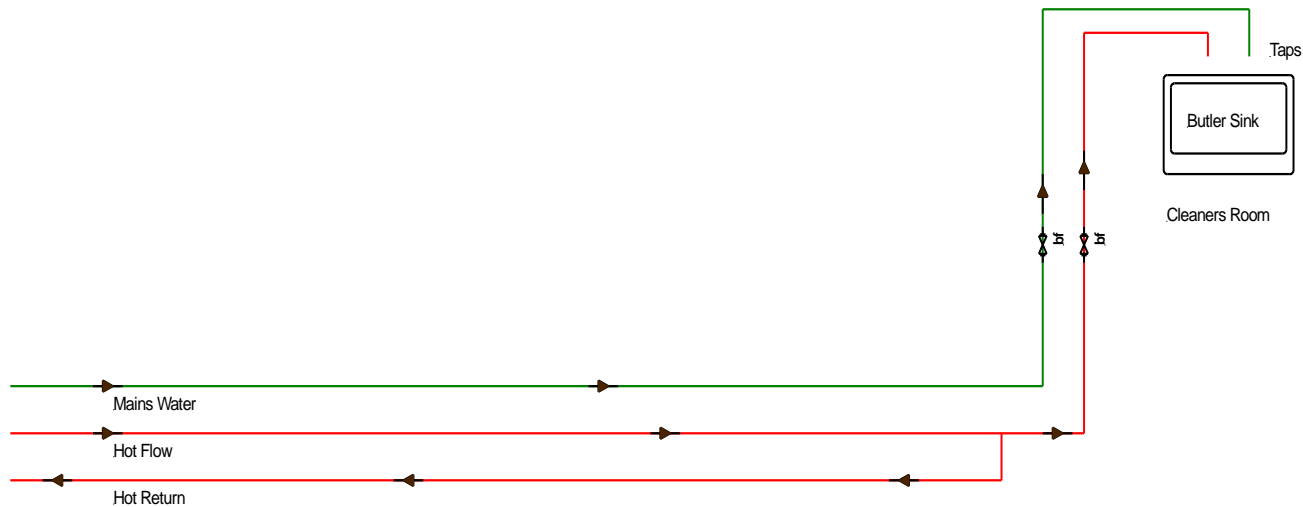

Date 31st May 2018

Drawing No.32

CA4



### KEY

-  Ball A Fix Valve
-  bf
-  Check Valve
-  Laboratory Tap
-  Blender Valve
-  Pump
-  Isolating Valve
-  Safety Valve
-  Drinking Fountain
-  Shower
-  Mains Water Service
-  Cold Water Down Service
-  Hot Flow/Return

### Note

This drawing was prepared for the Legionellosis Risk Assessment Report and not intended as a scaled system drawing.

Drawings are based on a visual inspection carried out during the Risk Assessment and information given at the time of the survey.

Some areas of pipe work may not have been visible during the survey therefore some assumptions may have been made in order to create this drawing.

This drawing is not to scale.

*Freeston Water Treatment  
Unit 1  
Lulworth Business Centre  
Calmore Industrial Estate  
Totton Southampton  
SO40 3WW  
Tel 02380669713*

Site Ref  
Sholing Technology College  
Art Block  
Textiles Prep Room  
Cleaners Room CA5  
Date 31st May 2018

CA5

Drawing No.33

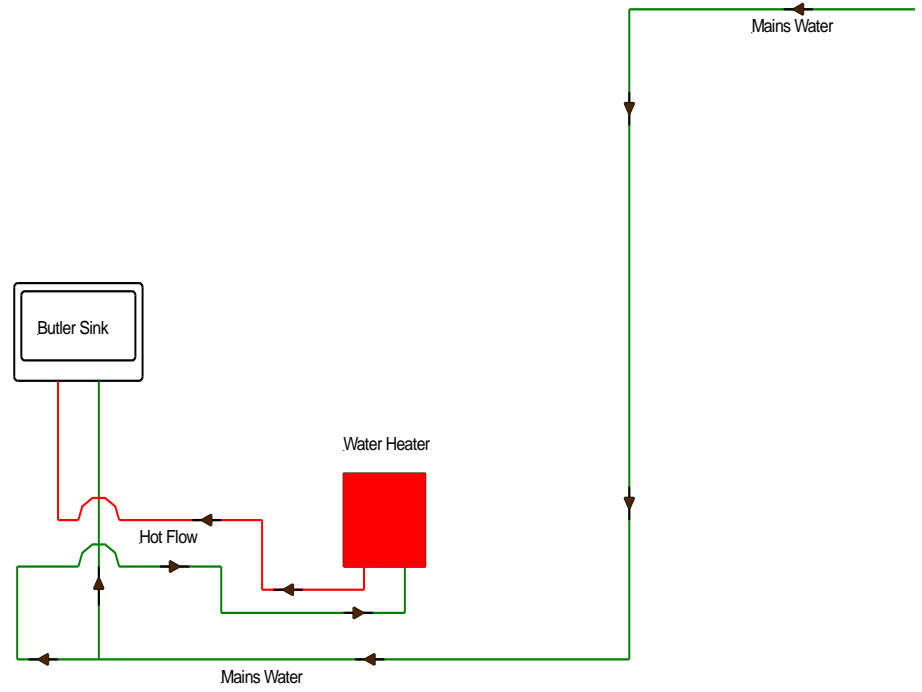

**KEY**

-  Ball A Fix Valve
-  bf
-  Check Valve
-  Laboratory Tap
-  Blender Valve
-  Pump
-  Isolating Valve
-  Safety Valve
-  Drinking Fountain
-  Shower
-  Mains Water Service
-  Cold Water Down Service
-  Hot Flow/Return







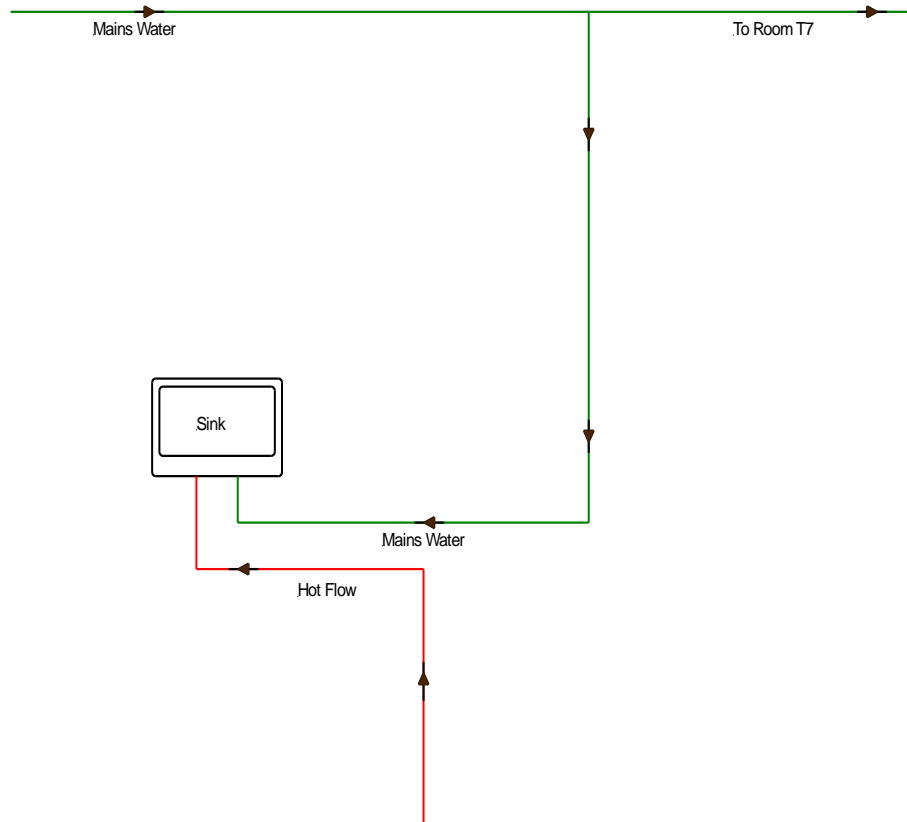

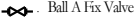

**Note**

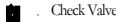
This drawing was prepared for the Legionellosis Risk Assessment Report and not intended as a scaled system drawing. Drawings are based on a visual inspection carried out during the Risk Assessment and information given at the time of the survey. Some areas of pipe work may not have been visible during the survey therefore some assumptions may have been made in order to create this drawing. This drawing is not to scale.

*Freeston Water Treatment  
Unit 1  
Lulworth Business Centre  
Calmore Industrial Estate  
Totton Southampton  
SO40 3WW  
Tel 02380669713*

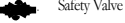

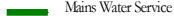
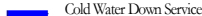
**KEY**

-  Ball A Fix Valve
-  bf
-  Check Valve
-  Laboratory Tap
-  Blender Valve
-  Pump
-  Isolating Valve
-  Safety Valve
-  Drinking Fountain
-  Shower
-  Mains Water Service
-  Cold Water Down Service
-  Hot Flow/Return

**Note**

This drawing was prepared for the Legionellosis Risk Assessment Report and not intended as a scaled system drawing. Drawings are based on a visual inspection carried out during the Risk Assessment and information given at the time of the survey. Some areas of pipe work may not have been visible during the survey therefore some assumptions may have been made in order to create this drawing. This drawing is not to scale.

*Freeston Water Treatment  
Unit 1  
Lulworth Business Centre  
Calmore Industrial Estate  
Totton Southampton  
SO40 3WW  
Tel 02380669713*







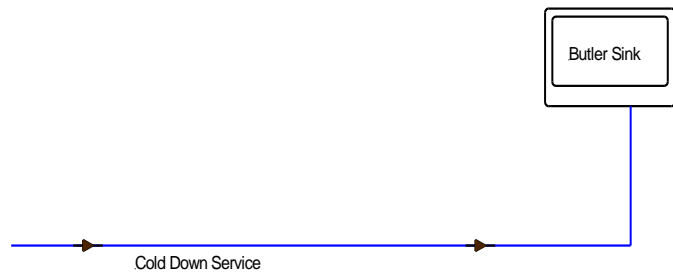





Site Ref  
Sholing Technology College  
Main Building Ground Floor  
Room 14 T8

Date 31st May 2018

Drawing No.35



### KEY

-  Ball A Fix Valve
- bf**  Check Valve
-  Laboratory Tap
-  Blender Valve
-  Pump
-  Isolating Valve
-  Safety Valve
-  Drinking Fountain
-  Shower
-  Mains Water Service
-  Cold Water Down Service
-  Hot Flow/Return

### Note

This drawing was prepared for the Legionellosis Risk Assessment Report and not intended as a scaled system drawing.  
 Drawings are based on a visual inspection carried out during the Risk Assessment and information given at the time of the survey.  
 Some areas of pipe work may not have been visible during the survey therefore some assumptions may have been made in order to create this drawing.  
 This drawing is not to scale.

**Freeston Water Treatment  
 Unit 1  
 Lulworth Business Centre  
 Calmore Industrial Estate  
 Totton Southampton  
 SO40 3WW  
 Tel 02380669713**

T3

Site Ref  
 Sholing Technology College  
 Main Building Ground Floor  
 Room 15 T3

Date 31st May 2018

Drawing No.36

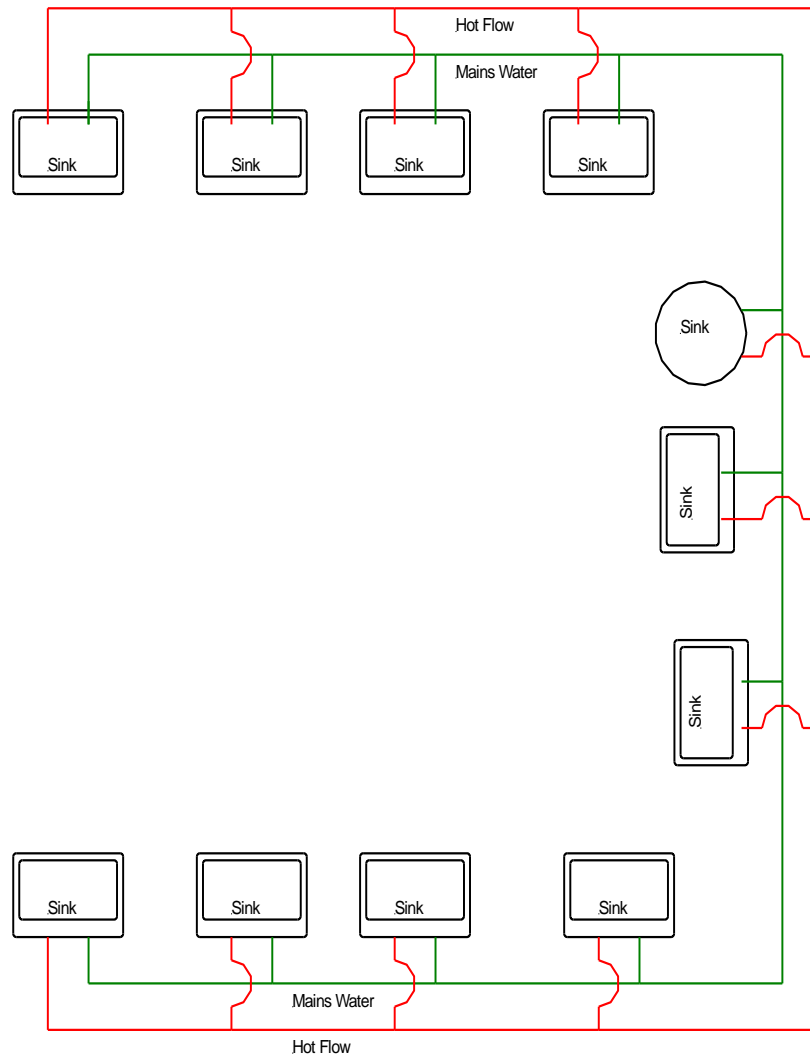
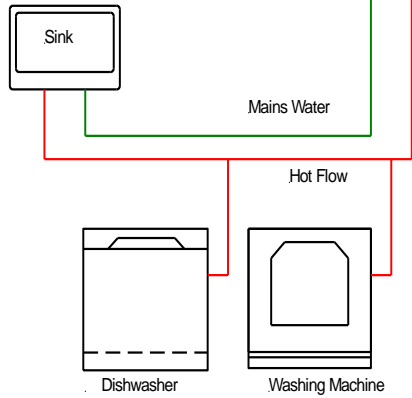

## KEY

-  Ball A Fix Valve
-  bf
-  Check Valve
-  Laboratory Tap
-  Blender Valve
-  Pump
-  Isolating Valve
-  Safety Valve
-  Drinking Fountain
-  Shower
-  Mains Water Service
-  Cold Water Down Service
-  Hot Flow/Return

## Note

This drawing was prepared for the Legionellosis Risk Assessment Report and not intended as a scaled system drawing. Drawings are based on a visual inspection carried out during the Risk Assessment and information given at the time of the survey. Some areas of pipe work may not have been visible during the survey therefore some assumptions may have been made in order to create this drawing. This drawing is not to scale.

**Freeston Water Treatment Unit 1**  
**Lulworth Business Centre**  
**Calmore Industrial Estate**  
**Totton Southampton**  
**SO40 3WW**  
**Tel 02380669713**







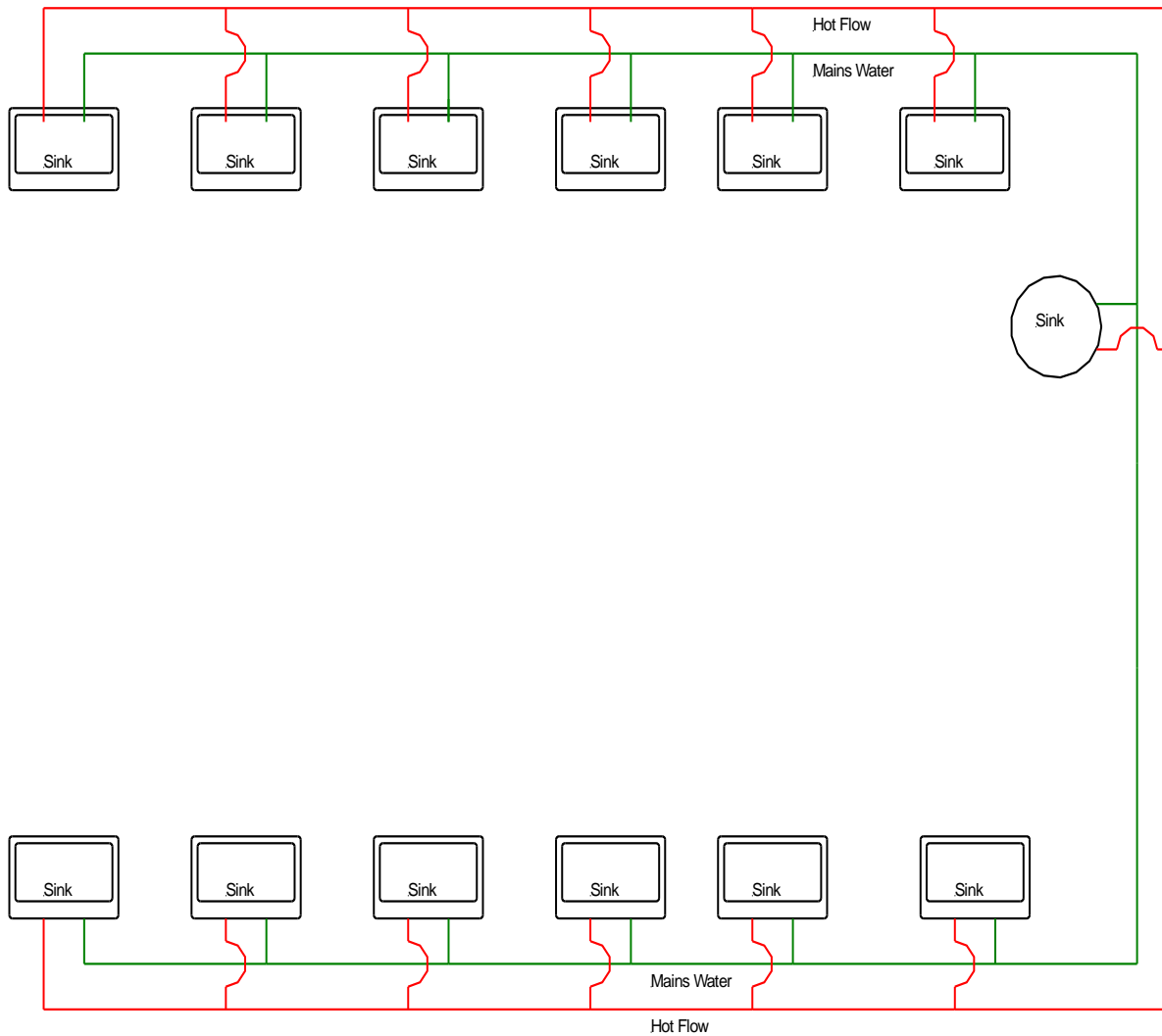





Site Ref  
 Sholing Technology College  
 Main Building Ground Floor  
 Food 1 & Prep Room

Date 31st May 2018

Drawing No.37 T1



## KEY

-  Ball A Fix Valve
-  bf
-  Check Valve
-  Laboratory Tap
-  Blender Valve
-  Pump
-  Isolating Valve
-  Safety Valve
-  Drinking Fountain
-  Shower
-  Mains Water Service
-  Cold Water Down Service
-  Hot Flow/Return

### Note

This drawing was prepared for the Legionellosis Risk Assessment Report and not intended as a scaled system drawing.  
 Drawings are based on a visual inspection carried out during the Risk Assessment and information given at the time of the survey.  
 Some areas of pipe work may not have been visible during the survey therefore some assumptions may have been made in order to create this drawing.  
 This drawing is not to scale.

*Freeston Water Treatment  
 Unit 1  
 Lulworth Business Centre  
 Calmore Industrial Estate  
 Totton Southampton  
 SO40 3WW  
 Tel 02380669713*

Site Ref  
 Sholing Technology College  
 Main Building Ground Floor  
 Food 2 T2

Date 31st May 2018

Drawing No.38

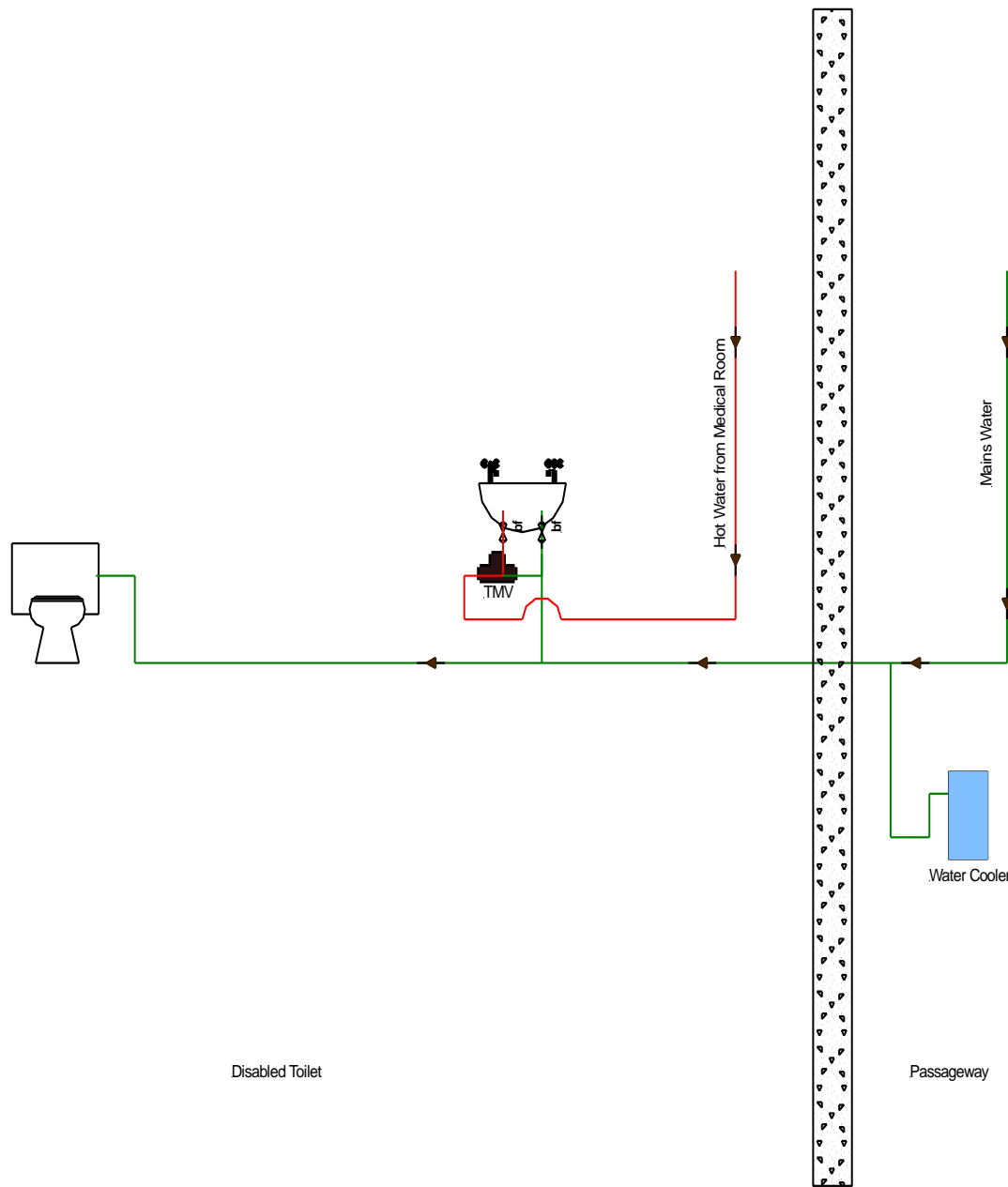

### KEY

-  Ball A Fix Valve
-  bf
-  Check Valve
-  Laboratory Tap
-  Blender Valve
-  Pump
-  Isolating Valve
-  Safety Valve
-  Drinking Fountain
-  Shower
-  Mains Water Service
-  Cold Water Down Service
-  Hot Flow/Return

### Note

This drawing was prepared for the Legionellosis Risk Assessment Report and not intended as a scaled system drawing. Drawings are based on a visual inspection carried out during the Risk Assessment and information given at the time of the survey. Some areas of pipe work may not have been visible during the survey therefore some assumptions may have been made in order to create this drawing. This drawing is not to scale.

**Freeston Water Treatment  
Unit 1  
Lulworth Business Centre  
Calmore Industrial Estate  
Totton Southampton  
SO40 3WW  
Tel 02380669713**

Site Ref  
Sholing Technical College  
Main Building Ground Floor  
Medical Room Area  
Disabled Toilet  
Date 31st May 2018

Drawing No.39



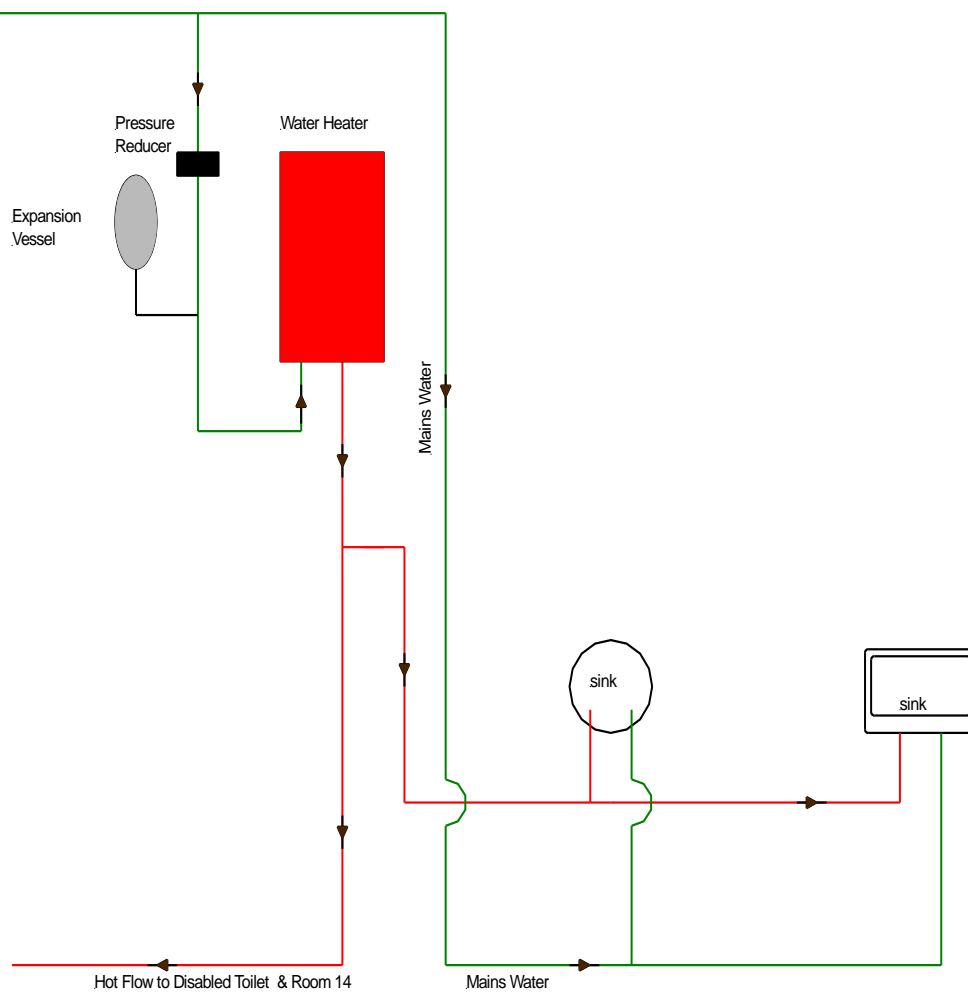

**KEY**

-  Ball A Fix Valve
-  bf
-  Check Valve
-  Laboratory Tap
-  Blender Valve
-  Pump
-  Isolating Valve
-  Safety Valve
-  Drinking Fountain
-  Shower
-  Mains Water Service
-  Cold Water Down Service
-  Hot Flow/Return

**Note**

This drawing was prepared for the Legionellosis Risk Assessment Report and not intended as a scaled system drawing. Drawings are based on a visual inspection carried out during the Risk Assessment and information given at the time of the survey. Some areas of pipe work may not have been visible during the survey therefore some assumptions may have been made in order to create this drawing. This drawing is not to scale.

*Freeston Water Treatment  
Unit 1  
Lulworth Business Centre  
Calmore Industrial Estate  
Totton Southampton  
SO40 3WW  
Tel 02380669713*

Site Ref  
Sholing Technical College  
Main Building Ground Floor  
Medical Room

Date 31st May 2018

Drawing No.40

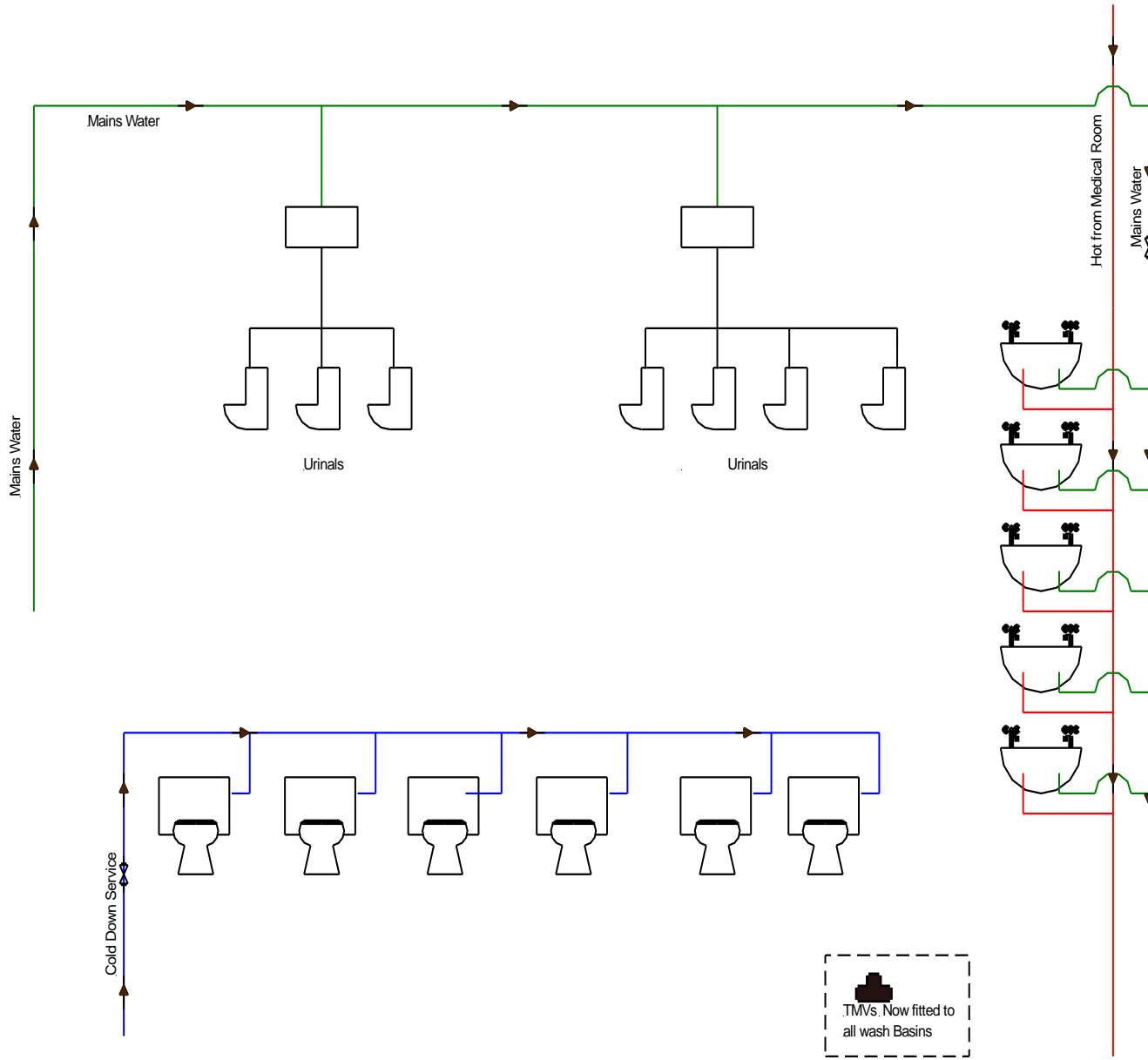

### KEY

-  Ball A Fix Valve
-  bf
-  Check Valve
-  Laboratory Tap
-  Blender Valve
-  Pump
-  Isolating Valve
-  Safety Valve
-  Drinking Fountain
-  Shower
-  Mains Water Service
-  Cold Water Down Service
-  Hot Flow/Return

### Note

This drawing was prepared for the Legionellosis Risk Assessment Report and not intended as a scaled system drawing. Drawings are based on a visual inspection carried out during the Risk Assessment and information given at the time of the survey. Some areas of pipe work may not have been visible during the survey therefore some assumptions may have been made in order to create this drawing. This drawing is not to scale.

**Freeston Water Treatment Unit 1**  
**Lulworth Business Centre**  
**Calmore Industrial Estate**  
**Totton Southampton**  
**SO40 3WW**  
**Tel 02380669713**

Site Ref  
 Sholing Technical College  
 Main Building Ground Floor  
 Boys Toilet

Date 31st May 2018

Drawing No.41

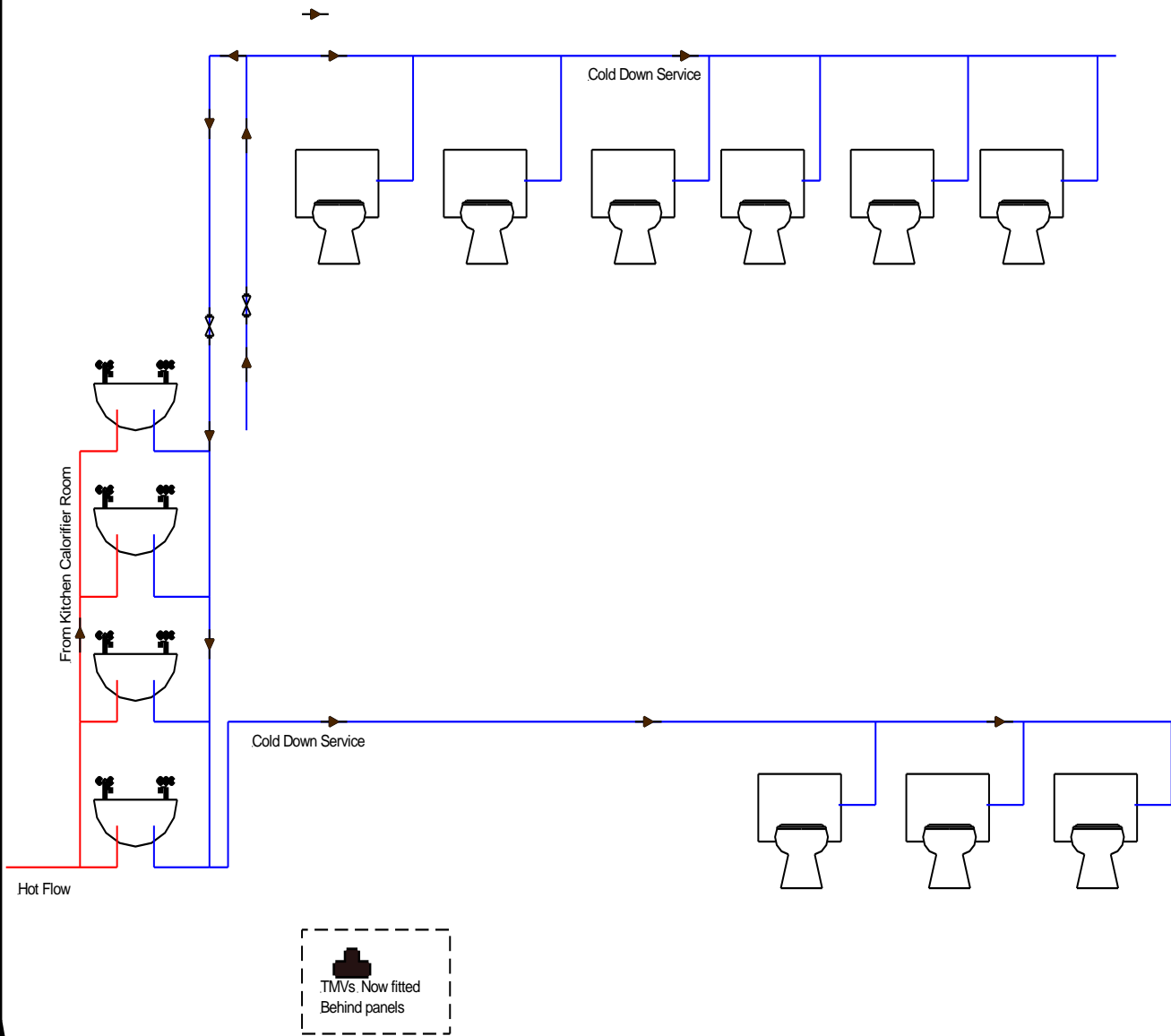

### KEY

-  Ball A Fix Valve
-  bf
-  Check Valve
-  Laboratory Tap
-  Blender Valve
-  Pump
-  Isolating Valve
-  Safety Valve
-  Drinking Fountain
-  Shower
-  Mains Water Service
-  Cold Water Down Service
-  Hot Flow/Return

### Note

This drawing was prepared for the Legionellosis Risk Assessment Report and not intended as a scaled system drawing. Drawings are based on a visual inspection carried out during the Risk Assessment and information given at the time of the survey. Some areas of pipe work may not have been visible during the survey therefore some assumptions may have been made in order to create this drawing. This drawing is not to scale.

**Freeston Water Treatment Unit 1**  
**Lulworth Business Centre**  
**Calmore Industrial Estate**  
**Totton Southampton**  
**SO40 3WW**  
**Tel 02380669713**

Site Ref  
 Sholing Technical College  
 Main Building Ground Floor  
 Girls Toilets by Kitchen

Date 31st May 2018

Drawing No.42

## KEY

-  Ball A Fix Valve
-  bf
-  Check Valve
-  Laboratory Tap
-  Blender Valve
-  Pump
-  Isolating Valve
-  Safety Valve
-  Drinking Fountain
-  Shower
-  Mains Water Service
-  Cold Water Down Service
-  Hot Flow/Return

### Note

This drawing was prepared for the Legionellosis Risk Assessment Report and not intended as a scaled system drawing. Drawings are based on a visual inspection carried out during the Risk Assessment and information given at the time of the survey. Some areas of pipe work may not have been visible during the survey therefore some assumptions may have been made in order to create this drawing. This drawing is not to scale.

*Freeston Water Treatment  
Unit 1  
Lulworth Business Centre  
Calmore Industrial Estate  
Totton Southampton  
SO40 3WW  
Tel 02380669713*

Site Ref  
Sholing Technical College  
Main Building First Floor  
Staff Room

Date 31st May 2018

Drawing No.43

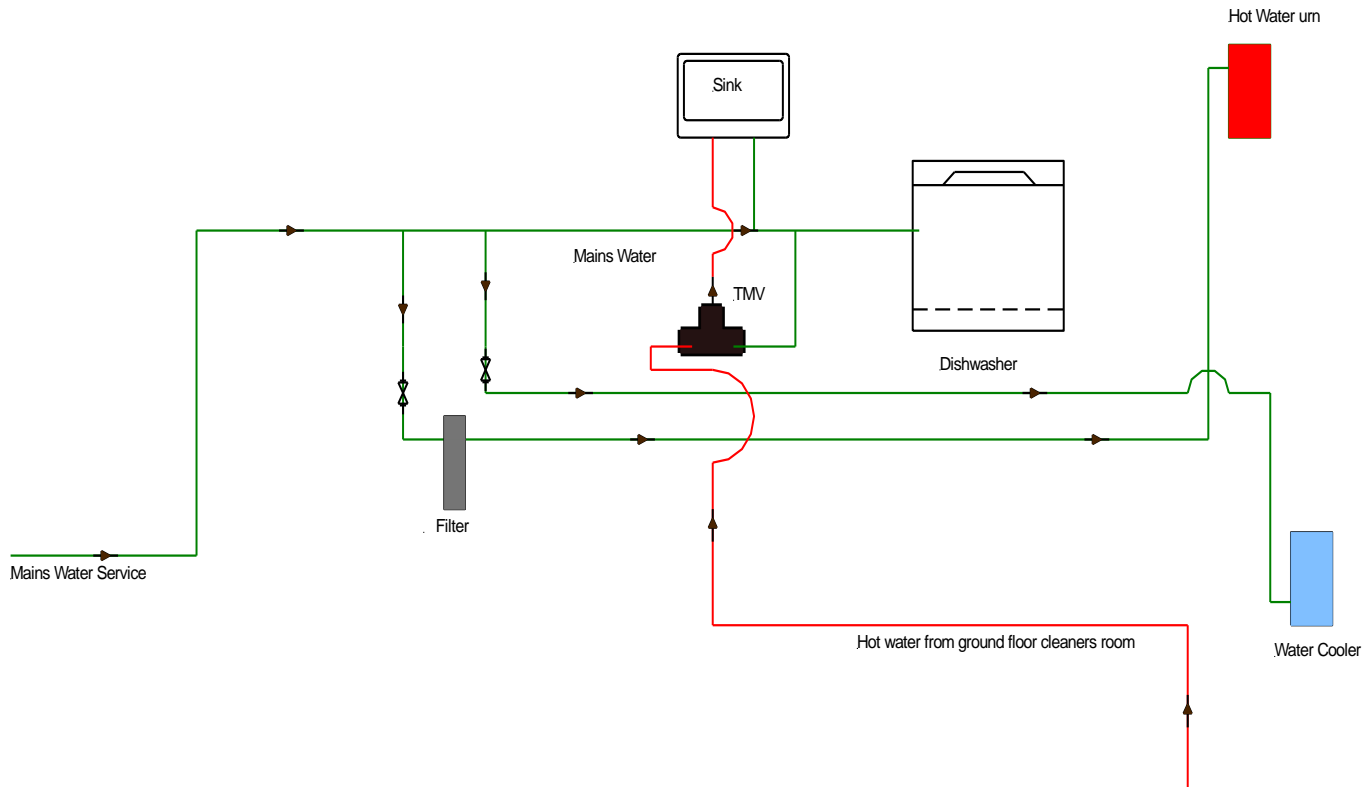

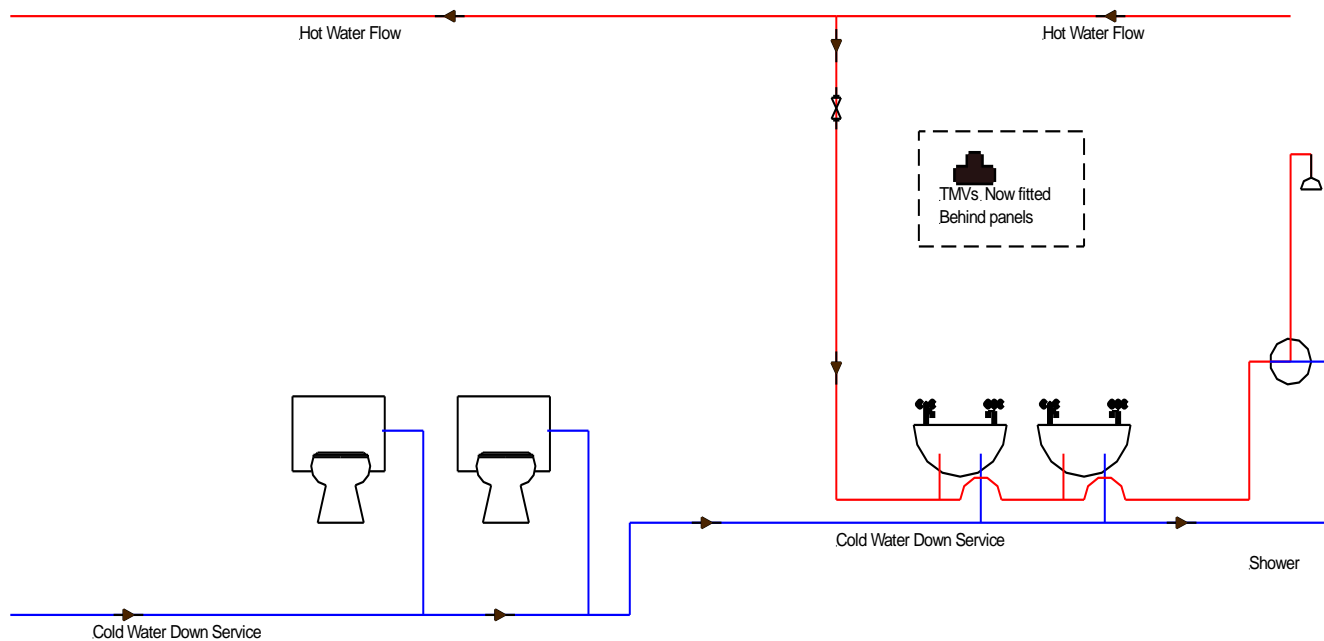

### KEY

-  Ball A Fix Valve
-  Check Valve
-  Laboratory Tap
-  Blender Valve
-  Pump
-  Isolating Valve
-  Safety Valve
-  Drinking Fountain
-  Shower
-  Mains Water Service
-  Cold Water Down Service
-  Hot Flow/Return

### Note

This drawing was prepared for the Legionellosis Risk Assessment Report and not intended as a scaled system drawing.

Drawings are based on a visual inspection carried out during the Risk Assessment and information given at the time of the survey.

Some areas of pipe work may not have been visible during the survey therefore some assumptions may have been made in order to create this drawing.

This drawing is not to scale.

*Freeston Water Treatment  
Unit 1  
Lulworth Business Centre  
Calmore Industrial Estate  
Totton Southampton  
SO40 3WW  
Tel 02380669713*

Site Ref  
Sholing Technical College  
Main Building Ground Floor  
Gents Toilet

Date 31st May 2018

Drawing No.44

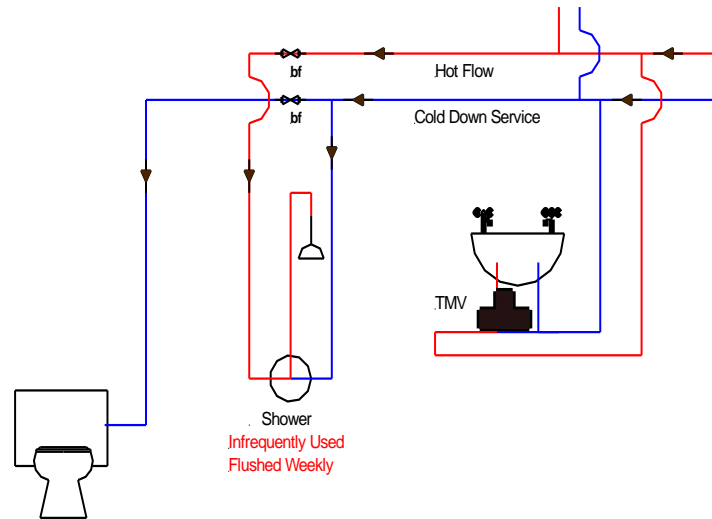
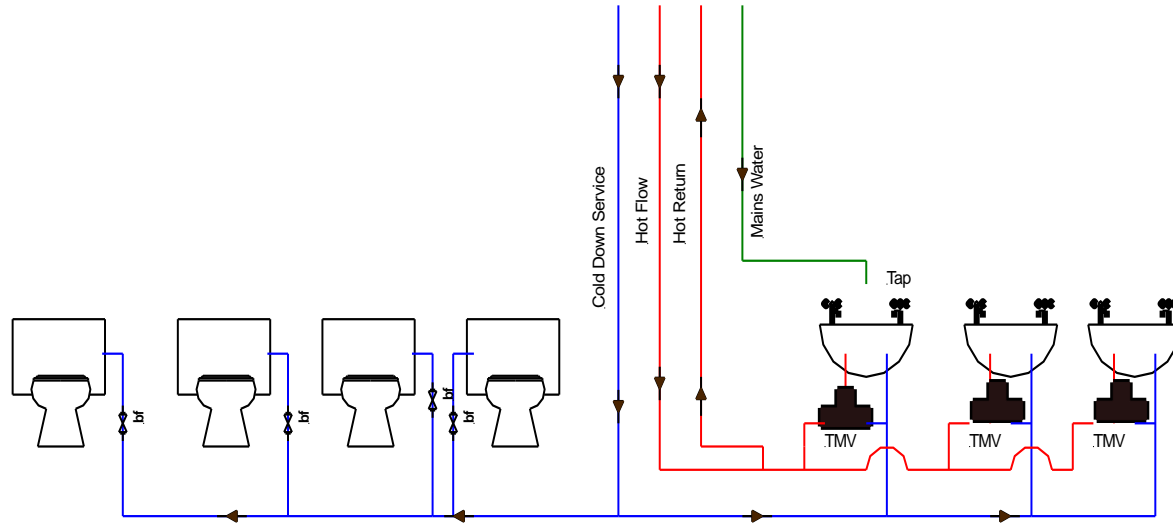

## KEY

-  Ball A Fix Valve
-  bf
-  Check Valve
-  Laboratory Tap
-  Blender Valve
-  Pump
-  Isolating Valve
-  Safety Valve
-  Drinking Fountain
-  Shower
-  Mains Water Service
-  Cold Water Down Service
-  Hot Flow/Return

## Note

This drawing was prepared for the Legionellosis Risk Assessment Report and not intended as a scaled system drawing. Drawings are based on a visual inspection carried out during the Risk Assessment and information given at the time of the survey. Some areas of pipe work may not have been visible during the survey therefore some assumptions may have been made in order to create this drawing. This drawing is not to scale.

**Freeston Water Treatment Unit 1**  
**Lulworth Business Centre**  
**Calmore Industrial Estate**  
**Totton Southampton**  
**SO40 3WW**  
**Tel 02380669713**

Site Ref  
 Sholing Technical College  
 Main Building Ground Floor  
 Ladies Toilet

Date 31st May 2018

Drawing No.45

### KEY

-  Ball A Fix Valve
- bf** Check Valve
-  Check Valve
-  Laboratory Tap
-  Blender Valve
-  Pump
-  Isolating Valve
-  Safety Valve
-  Drinking Fountain
-  Shower
-  Mains Water Service
-  Cold Water Down Service
-  Hot Flow/Return

### Note

This drawing was prepared for the Legionellosis Risk Assessment Report and not intended as a scaled system drawing.  
Drawings are based on a visual inspection carried out during the Risk Assessment and information given at the time of the survey.  
Some areas of pipe work may not have been visible during the survey therefore some assumptions may have been made in order to create this drawing.  
This drawing is not to scale.

**Freeston Water Treatment  
Unit 1  
Lulworth Business Centre  
Calmore Industrial Estate  
Totton Southampton  
SO40 3WW  
Tel 02380669713**

Site Ref  
Sholing Technical College  
Main Building Ground Floor  
Site Managers Office

Date 31st May 2018

Drawing No.46

Outside Tap  
Infrequently Used

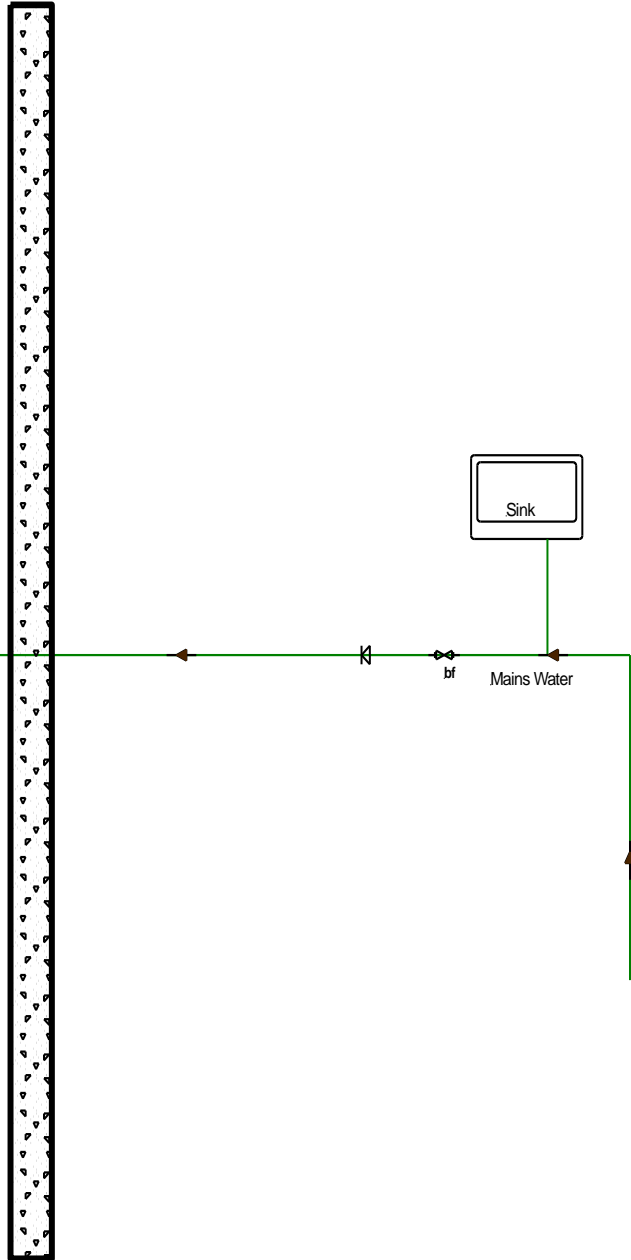

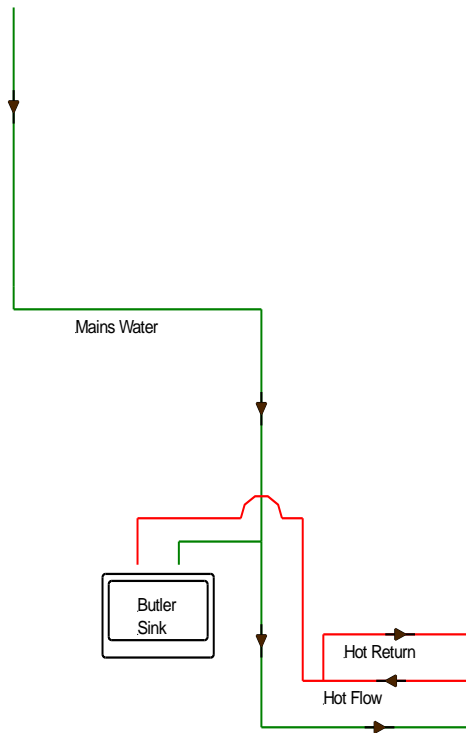

Cleaners Cupboard

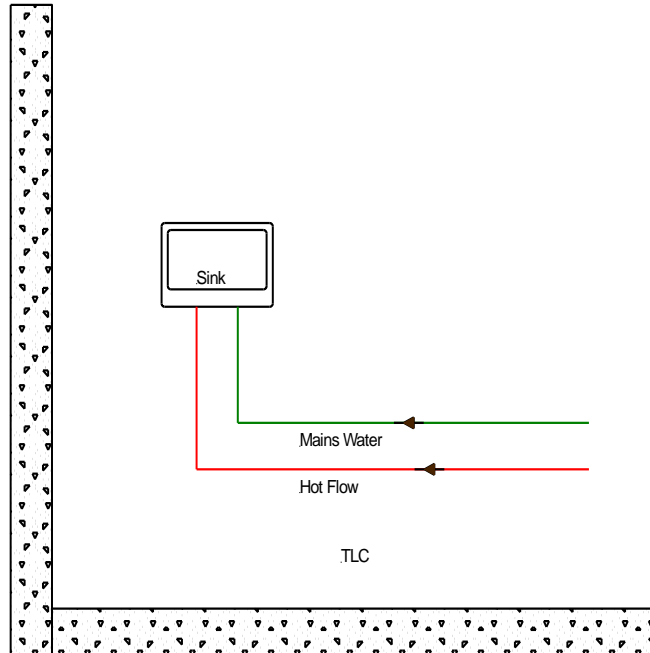

TLC

### KEY

-  Ball A Fix Valve
- bf**
-  Check Valve
-  Laboratory Tap
-  Blender Valve
-  Pump
-  Isolating Valve
-  Safety Valve
-  Drinking Fountain
-  Shower
-  Mains Water Service
-  Cold Water Down Service
-  Hot Flow/Return

### Note

This drawing was prepared for the Legionellosis Risk Assessment Report and not intended as a scaled system drawing.

Drawings are based on a visual inspection carried out during the Risk Assessment and information given at the time of the survey.

Some areas of pipe work may not have been visible during the survey therefore some assumptions may have been made in order to create this drawing.

This drawing is not to scale.

**Freeston Water Treatment  
Unit 1  
Lulworth Business Centre  
Calmore Industrial Estate  
Totton Southampton  
SO40 3WW  
Tel 02380669713**

Site Ref  
Sholing Technology College  
Science Block  
Kitchen & Cleaners Cupboard

Date 31st May 2018

Drawing No.47



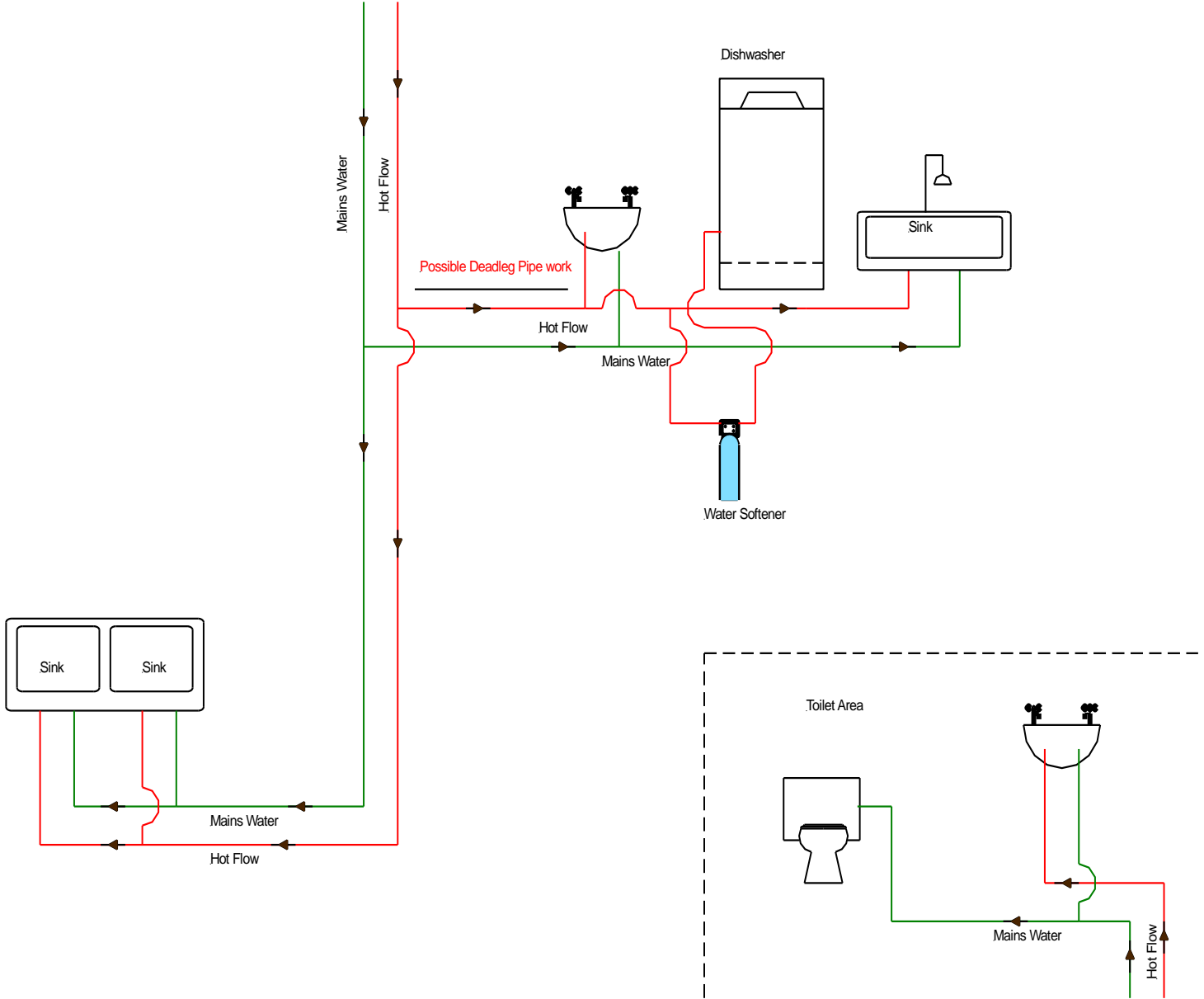

**KEY**

- Ball A Fix Valve
- bf
- Check Valve
- Laboratory Tap
- Blender Valve
- Pump
- Isolating Valve
- Safety Valve
- Drinking Fountain
- Shower
- Mains Water Service
- Cold Water Down Service
- Hot Flow/Return

**Note**

This drawing was prepared for the Legionellosis Risk Assessment Report and not intended as a scaled system drawing. Drawings are based on a visual inspection carried out during the Risk Assessment and information given at the time of the survey. Some areas of pipe work may not have been visible during the survey therefore some assumptions may have been made in order to create this drawing. This drawing is not to scale.

*Freeston Water Treatment Unit 1  
Lulworth Business Centre  
Calmore Industrial Estate  
Totton Southampton  
SO40 3WW  
Tel 02380669713*







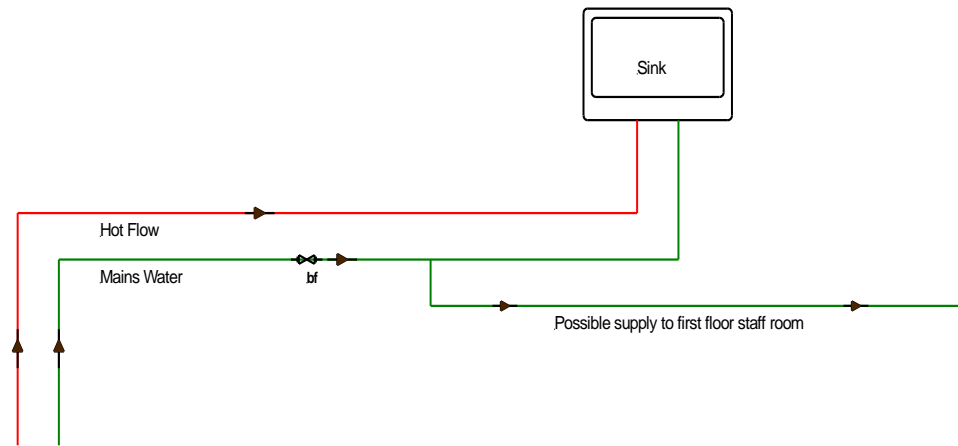





Site Ref  
Sholing Technical College  
Main Building Kitchen

Date 31st May 2018

Drawing No.48



## KEY

-  Ball A Fix Valve
- bf**
-  Check Valve
-  Laboratory Tap
-  Blender Valve
-  Pump
-  Isolating Valve
-  Safety Valve
-  Drinking Fountain
-  Shower
-  Mains Water Service
-  Cold Water Down Service
-  Hot Flow/Return

### Note

This drawing was prepared for the Legionellosis Risk Assessment Report and not intended as a scaled system drawing.

Drawings are based on a visual inspection carried out during the Risk Assessment and information given at the time of the survey.

Some areas of pipe work may not have been visible during the survey therefore some assumptions may have been made in order to create this drawing.

This drawing is not to scale.

*Freeston Water Treatment  
Unit 1  
Lulworth Business Centre  
Calmore Industrial Estate  
Totton Southampton  
SO40 3WW  
Tel 02380669713*

Site Ref  
Sholing Technical College  
Main Building First Floor  
Reprographics Room

Date 31st May 2018

Drawing No.49